

## BATHROOM FURNISHINGS



Art.-Nr.: 03507010401 Katalog Badeinrichtungen, englisch, 08/16

**FURNISHING CONCEPTS** 8-139

EDITION 400 8-53

EDITION 11 54-83

EDITION 300 84-95

ROYAL 60 98-111

ROYAL REFLEX 114-125

ROYAL UNIVERSE 126-137

**COSMETIC MIRRORS** 138-139

**PRODUCT OVERVIEW** 142-209

# A FASCINATION FOR THE BATHROOM



Hartmut Dalheimer, Managing Director



Engelbert Himrich, Managing Partner



Sensuousness and sensibility – KEUCO’s passion for the bathroom runs through its veins, and this is evident in our products. A KEUCO bathroom awakens the emotions. It is an intimate place of well-being. It conveys elegance and luxury, and it combines aesthetics, ergonomics and functionality.

In no other room is this challenge more exciting and demanding than the bathroom. That is why this fascination still drives us forward. Since its founding in the year 1953, our company, which is still family-run today, has undergone a rapid and sustained transformation. From market leader for high quality bathroom accessories, KEUCO has evolved into the brand for the bathroom, with a wide assortment of furniture, fittings, accessories and mirror cabinets and from our early days we focused on offering concepts of complete bathroom furnishings.

Important factors contributing to our success are the contemporary, technically innovative products, the highest standard of quality, a clear orientation towards design, and state-of-the-art manufacturing facilities. Today, KEUCO products are sold around the world, and are market leaders in many areas. They are the result of intensive development work, the use of the best materials, and the most careful workmanship. We combine high-tech manufacturing and involved hand craftsmanship to achieve optimum results. KEUCO quality sets standards: Our products will convince you by their immaculate surfaces, maximum longevity, and perfect functionality. Each article is examined individually before being shipped out.

At KEUCO, the subject of design already played a pivotal role long before it even became a general topic of conversation. Our understanding of design involves striving to achieve classic-modern aesthetics that retain their contemporary feel, even after many years of use. Whether designed in-house or in cooperation with internationally recognized designers – KEUCO products are regularly distinguished by renowned awards.

But timeless design and long-lasting product quality are only two aspects of our sustainability philosophy. Equally important are responsible company management, and resource-saving production – with the help of our own water conditioning system for our electroplating plant, for example. We view the label “Made in Germany” as commitment to the kind of company management that aims to secure jobs in the long term.

KEUCO products are made in our own production plants in Hemer, Gütersloh and Bünde. Inland production provides us with a close proximity that is essential, so that we can develop and utilize the know-how of our employees on a long term basis, and so achieve seamless quality management. And that makes “Made in Germany” a promise of quality.







EDITION 400

# OUR IDEA OF FREEDOM OF DESIGN



# PASSION MAKES THE DIFFERENCE

With EDITION 400, KEUCO is setting new trends in modern bathroom design. The design-oriented bathroom furnishing concept has a strong focus on individualisation. Every single one of the products in the series – from the bathroom furniture to the washbasins, the fittings to the accessories, the mirror cabinets to the light mirrors – beautifies with its uniquely delicate and simultaneously sculptural language of form. Versatile combination potential, colours and materials offer a wide spectrum of possibilities for intelligent, room-specific arrangements. Useful functions add order and convenience to the bathroom and establish a unique ambience. Distinguished with the "Design Plus" seal of quality, EDITION 400 – conceived by the design agency Tesseraux + Partner in Potsdam – sets new standards for the bathroom of the future.





# MODULARITY WHICH HAS BEEN THOUGHT THROUGH

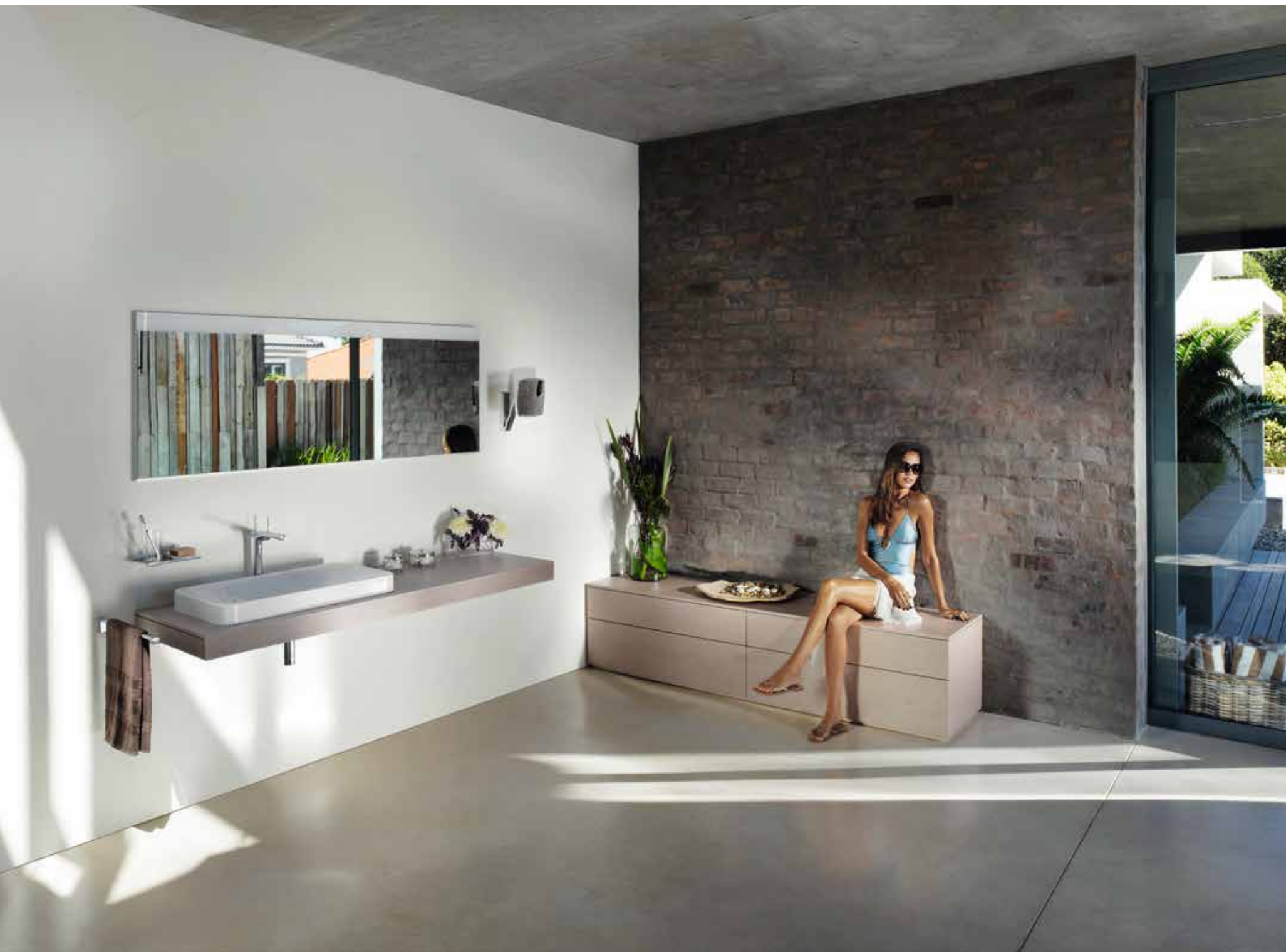

Fully in accordance with preference and demand, but always extremely clear: Versatile furniture and washbasin combinations offer a room-specific bathroom design and lifestyle in the bathroom. Thanks to the modular concept and the large variety of colours and materials of EDITION 400, there are no restrictions to personal creativity for planning your bathroom – regardless whether it's for families, couples or singles.

# BATHROOM DESIGN OF 1001 TYPE

At the heart of EDITION 400 is the exclusive washing area. The single and double washbasin solutions can be combined with the ceramic basins in widths of 600 mm or 800 mm, for versatile planning and design. Further combination possibilities with EDITION 11 or ROYAL 60 washbasins from KEUCO in their soft or rectangular styles open up an extremely wide choice of creative wash area designs with EDITION 400 – perfectly matching in combination with the respective mirror cabinets and light mirrors.













The wide range of furniture for the washbasin is completed by either wall-mounted or floor-standing side units, and middle and tall units. In the large selection of front surfaces, too, no wish is left unfulfilled: For example, various colours of structure lacquers are available whose special surface resembles natural materials. Classy real wood veneers, such as walnut, create a sensuous, natural atmosphere. Shiny or satin glass cover plates add an extravagant flair.



# CLEAR ORDER WITH LOTS OF ROOM



The reduced size of the external vanity unit provides generous interior storage space. This offers a large amount of storage space with system. The drawer units are available in two heights. For example, the drawers are opened with functional push-to-open technology and closed by means of a soft-close technology. Therefore, everything fits in to the structured geometry without handles and forms a clear architectonic line. The high quality inner compartment of the drawers ensures that everything remains where it belongs.







# SENSUOUS SHAPES IN GLEAMING CHROME

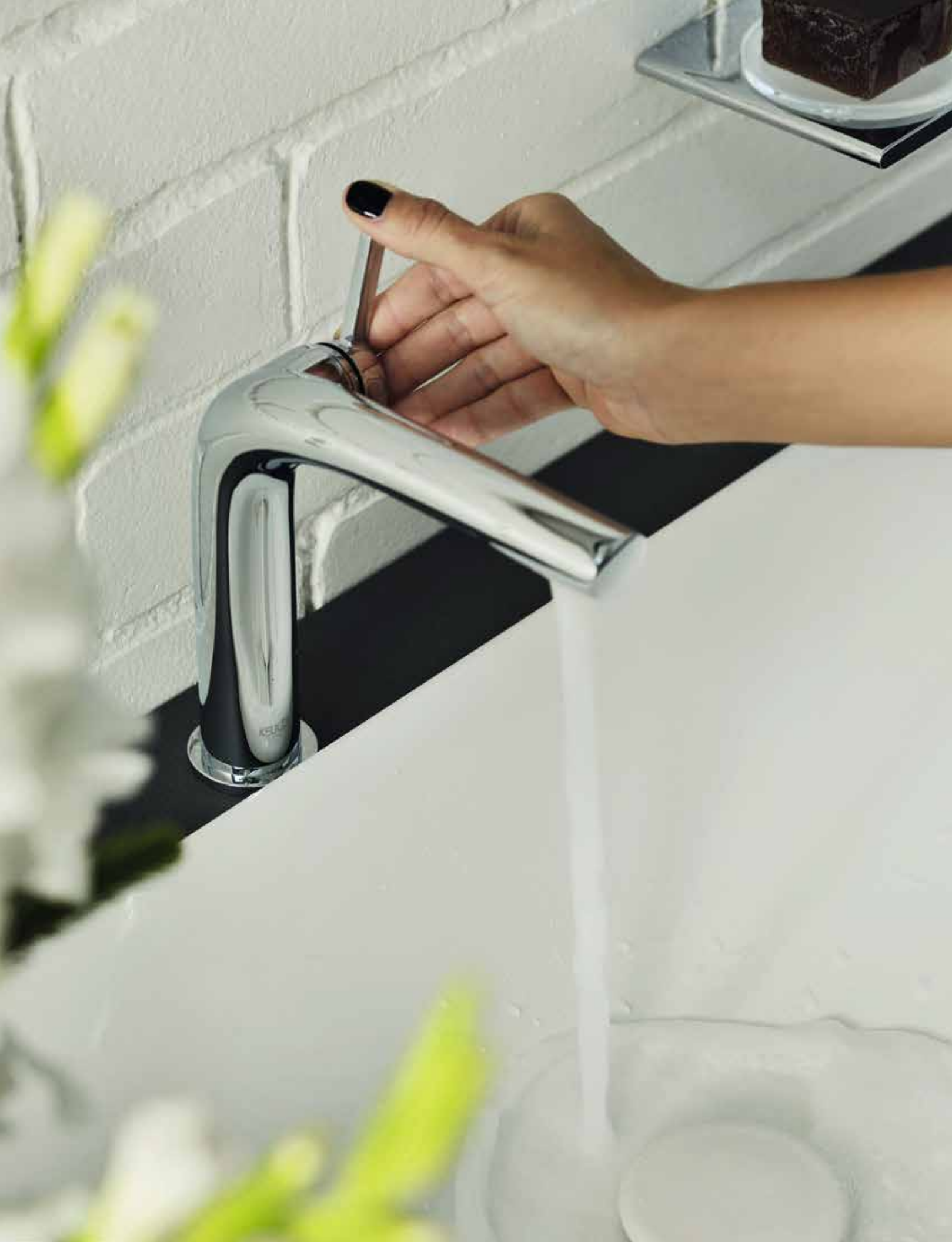

A characteristic of EDITION 400 is its sensuously beautiful style. The gleaming chrome-plated fittings of the series present themselves like filigree sculptures. Virtually works of art, their extraordinary presence almost makes you forget their actual purpose. Conceived by the design agency Tesseraux+Partner in Potsdam and rewarded the "Design Plus" seal of quality, they are a prominent stylish element in KEUCO's full range of bathroom furnishings.





# ELEGANCE MADE IN GERMANY



Perfection in detail is what makes EDITION 400 fittings especially stand out. The washbasin mixers in five sizes with discharge height of 80 mm to 290 mm for all types of washbasins prove this in excellent terms. The adjustable regulator, which cannot be seen from the outside, is a special feature that is integrated in the outlet. Moreover, EDITION 400 offers a range of different washbasin fittings, including a pillar tap, a single-lever mixer with a swivel spout, a wall fitting and a three-hole fitting.





# RELAX WHEN SHOWERING



The EDITION 400 fittings for the shower are just as remarkable: Not only is the hand shower sliding rail with hand shower bracket visually dazzling, but it is also extremely convenient to use. With its particularly slender design and normal, soft and massage jet, the hand shower guarantees extremely pleasant showering.

# CONCENTRATION ON THE ESSENTIALS



IXMO is nothing less than a small, major revolution in the bathroom. As the first in-wall fitting ever it combines minimalistic design with maximum functionality in as few individual modules as possible. This creates a unique design freedom to personalise the bathroom. All visible modules have the same small outreach and compared to other systems small decor disc dimensions. Discover the new player in the bathroom for yourself – with the interactive planning tool at [ixmo.de](http://ixmo.de).







# PURE DESIGN – THE LATEST TECHNOLOGY



The innovative illuminated mirrors are a special highlight. The EDITION 400 illuminated mirror presents itself with remarkably elegant slenderness and a surrounding aluminium edge. Customized dimensions are available on request. Its secret: A special light-conducting material conducts the light of the LED to the surface and provides the ideal lighting for the room or face at all times. With unobtrusive and intelligent sensor controls the light can be dimmed and the light colour altered in an infinite number of steps: From bright-white daylight for ideal, day-to-day beauty care, right to a warm-white light, ideal for perfect evening make-up or an atmospheric bathing ambience. Moreover in every light situation the LED lighting is glare-free and long lasting, and it also saves energy and is maintenance free.

But the EDITION 400 light mirror can do much more: It is optionally available with mirror heater, which is a practical feature that prevents the mirror from misting up after taking a shower. Of the highest technical standard, the sensor-controlled mirror heater switches off again automatically 20 minutes after being switched on.



# STORAGE SPACE MEETS LIGHT TECHNOLOGY

The EDITION 400 mirror cabinet impresses both due to its beauty and its function. The continuous setting of light intensity and light temperature, a consistent reflection of the back and insides of the door, the clear internal lighting, as well as lots of space with an extra storage compartment and integrated electrical sockets make the mirror cabinet a useful and sensual part of your bathroom.

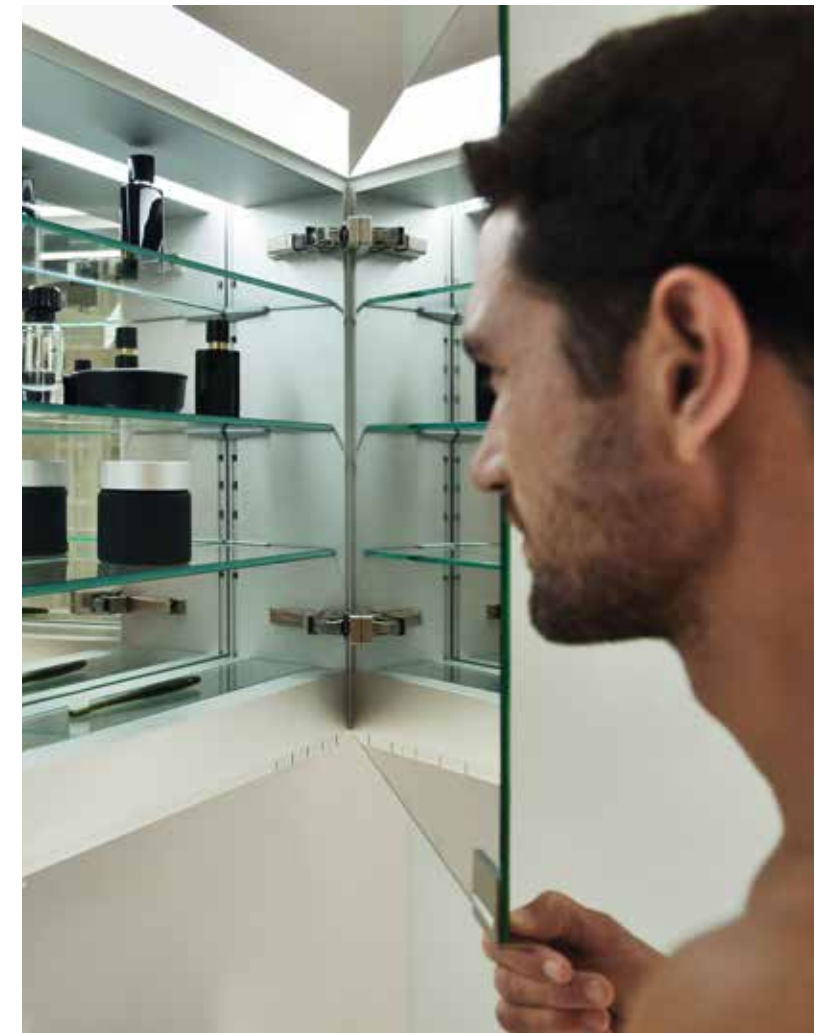

# INTELLIGENT USE OF ROOM IN THE WALL



A clear case of aesthetics: The built in mirror cabinet is discreetly fixed into the wall and blends with the room. The external, delicate silhouette does not immediately point to the generous depth of its interior.

Both light intensity and light temperature from daylight to warming light can be gently and continuously controlled, so that you will happily spend a little longer in front of this mirror.









# DELICATE DESIGN ACCESSORIES

An aesthetic of filigree design, special functional features in the details, and high quality – this is how EDITION 400 accessories set special accents and create a sensuous atmosphere in the bathroom. With their practical functionality and elegantly slender appearance they pamper the user.

Harmoniously coordinated in design are also the lotion dispenser and tumbler holder – two perfectly matching companions. Combined with a utensil shelf, the accessories add homely comfort to the bathroom.





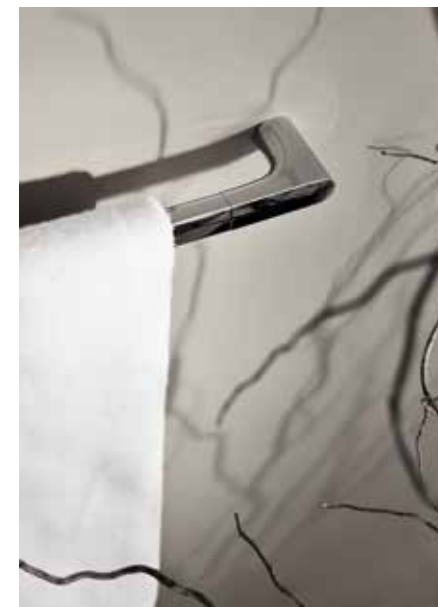

The variety of the products EDITION 400 offers an abundant selection of accessories for a sophisticated bathroom design. The hook segment alone ranges from a double towel hook to single towel hook. One special detail of the double towel hook is that the towel is hung up from the back – so the design is not hidden even when in use.





For an EDITION 400 bathroom with style and a feel-good ambience, the intelligent functionality of the accessories is the icing on the cake.

The shower shelf is made from high quality aluminium and is therefore especially resistant and stable. The shower shelf has the excellent feature of a "docking station" for the glass squeegee, which is not immediately apparent at a first glance. Harmoniously integrated into the design, it prevents shower articles from falling down.





Also around the toilet area, the EDITION 400 accessories are harmoniously integrated into the architectural environment of the bathroom design. With its particularly delicate design, the toilet paper holder demonstrates that it has the potential to become the next new classic. It is swivel-mounted, extremely delicate and can be easily attached to the wall. Even the wall-mounted toilet brush set impresses with its little secrets: On the outside it presents itself in fine, satin glass; inside it has a practical removable holder. The toilet brush hangs hygienically inside and it is concealed behind a lid.



FREEDOM IS  
HAVING A VARIETY  
OF POSSIBILITIES

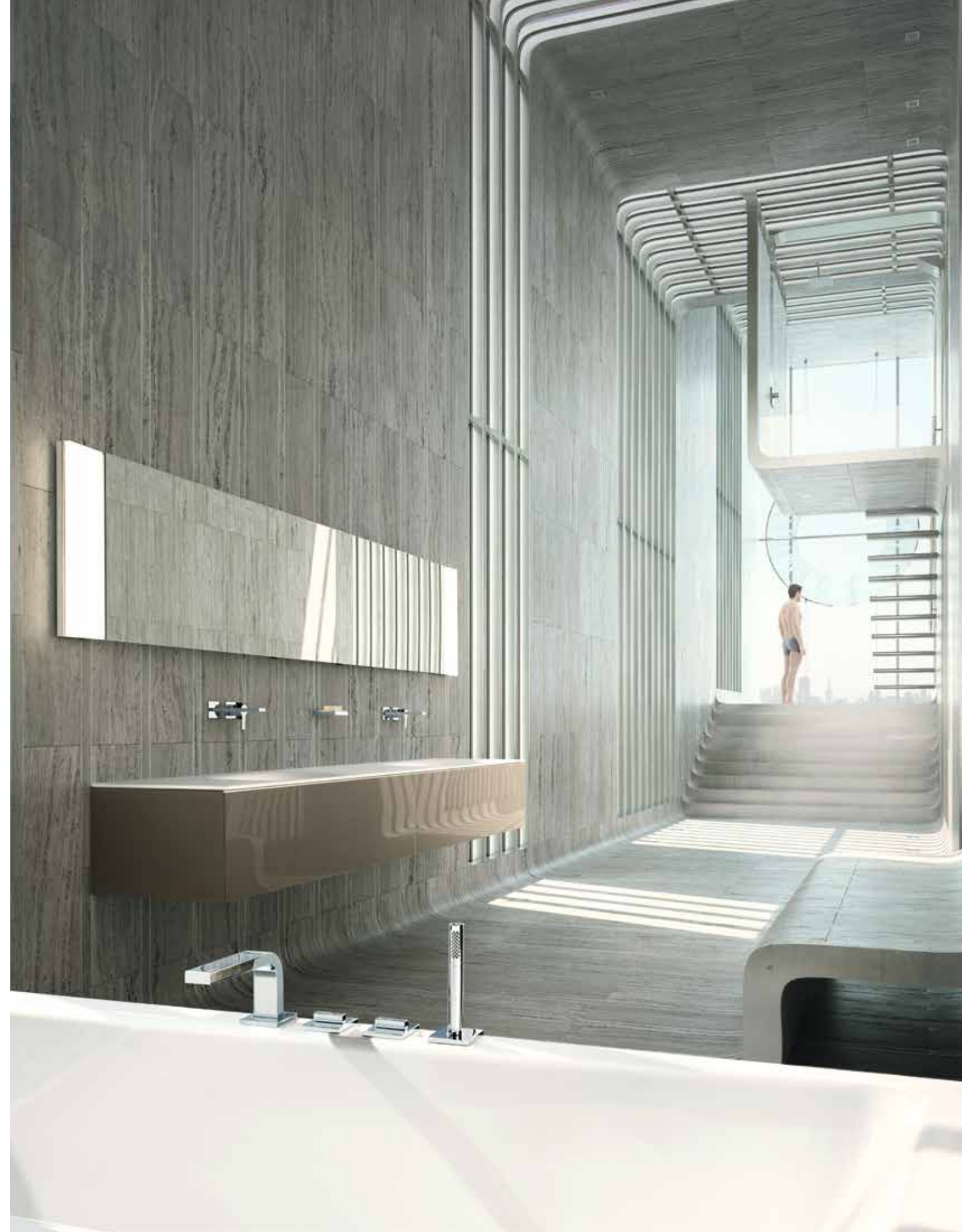



# PURE DESIGN – BUT NOT PURISTIC

A linear design, multiplied with an enormously rich variety from bathroom furniture to mirror cabinets and from fittings to accessories – that is EDITION 11. Designed by the renowned design agency Tesseroux+Partner, all components stand out with their sense of visual lightness, gentle beauty and feeling of uncompromising quality. One really feels their careful workmanship and innovative functionality at every use. This creates your own quality class in the bathroom, which is apparent for everyone and which always pays off.

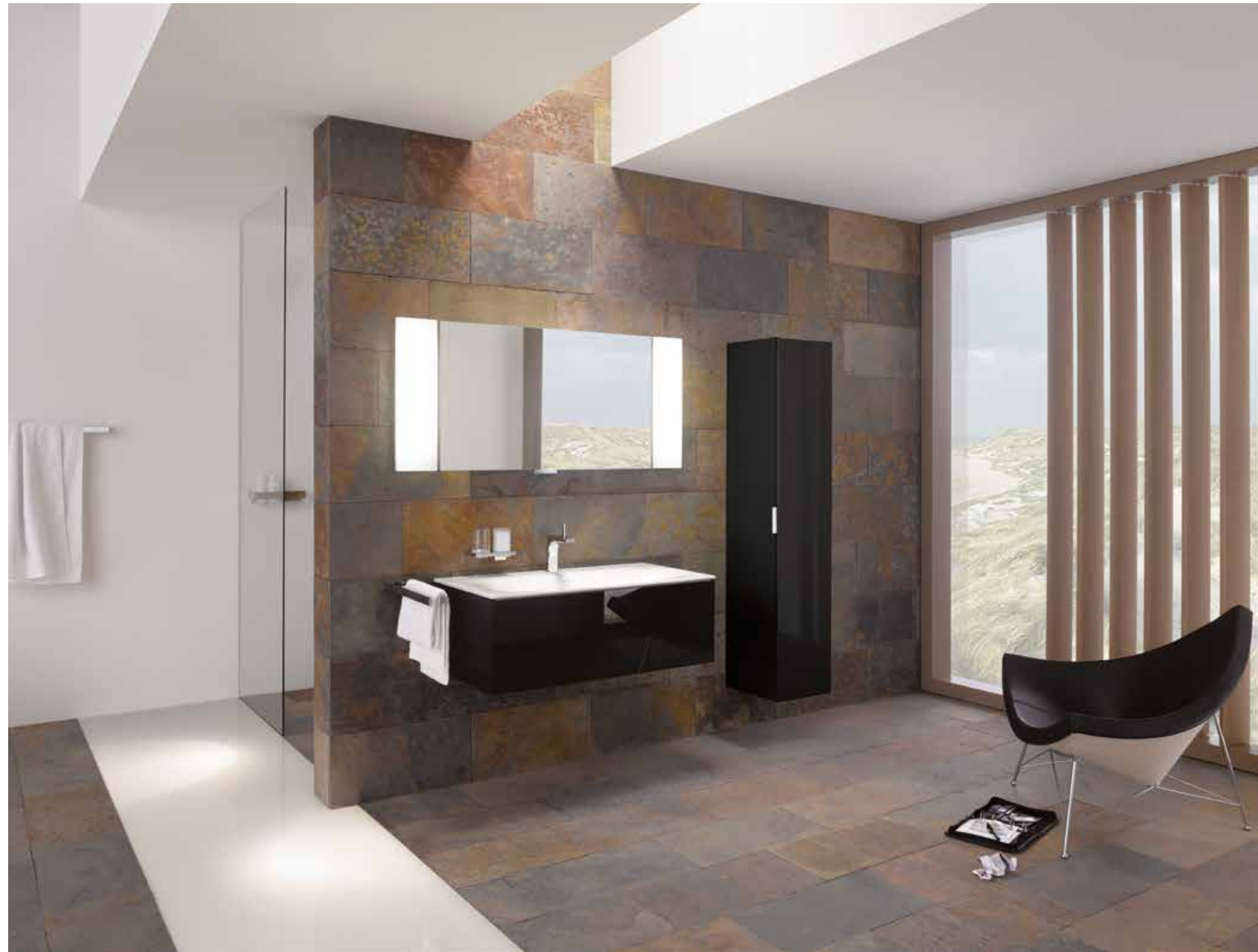

Tesseroux+Partner  
Dominik Tesseroux

# LIGHTWEIGHT AND SUSPENDED

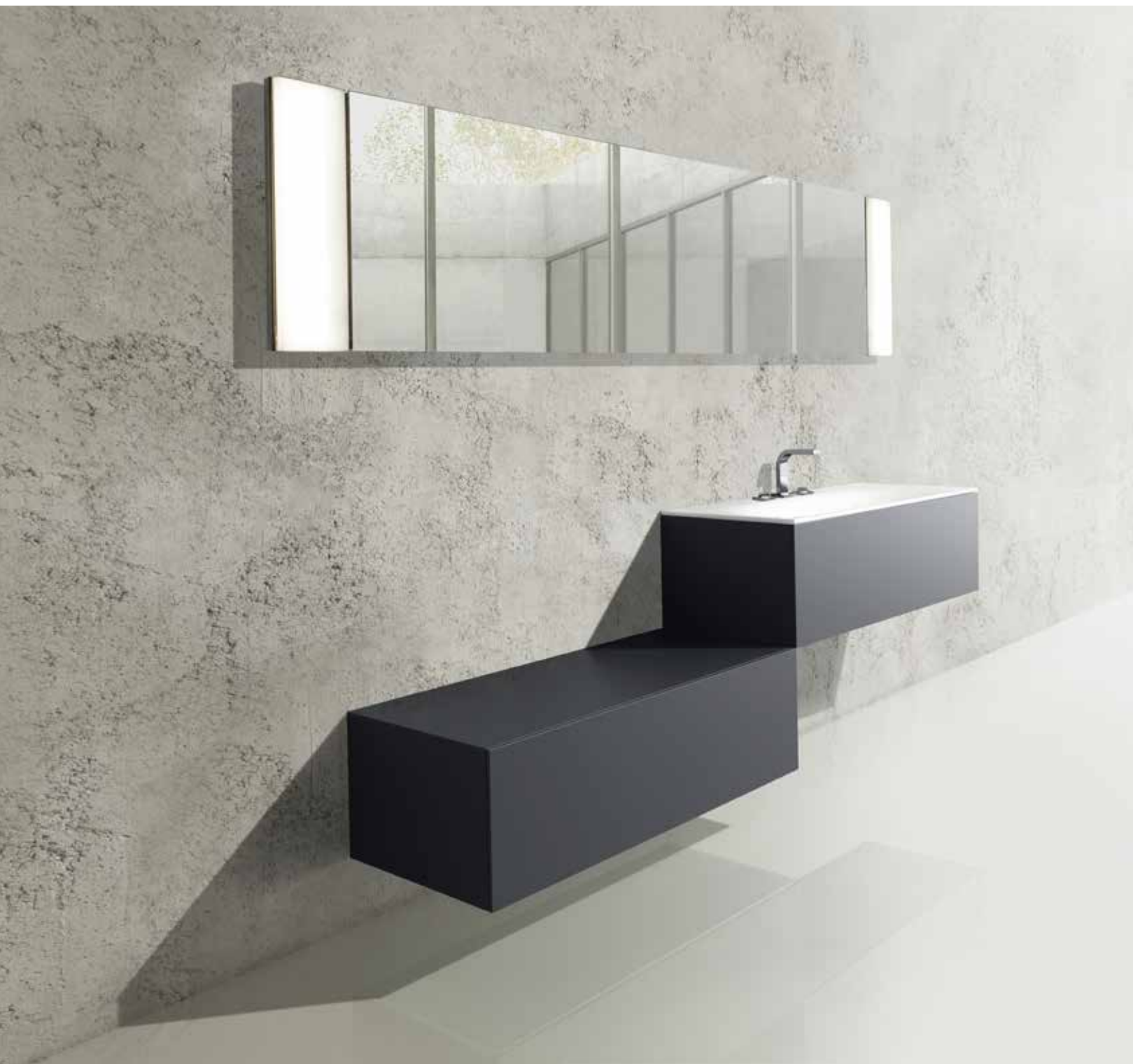

Because of its versatility, EDITION 11 offers the highest degree of freedom in bathroom design. This is assured by the selection of surfaces, the range of sizes and many other areas where a choice is available. The fronts, which seem to float on the face of the furniture, lend a special lightweight and elegant feel to the furniture. When the front drawer of the vanity unit glides open, its interior light switches on automatically. Tidiness is made easy with the freely positionable storage boxes. By combining two sizes, a generous work area is created beside the ceramic washbasin. The washbasin with its gently rounded vocabulary of form is available in the materials Varicor® and ceramic.



# PERFECT HARMONY

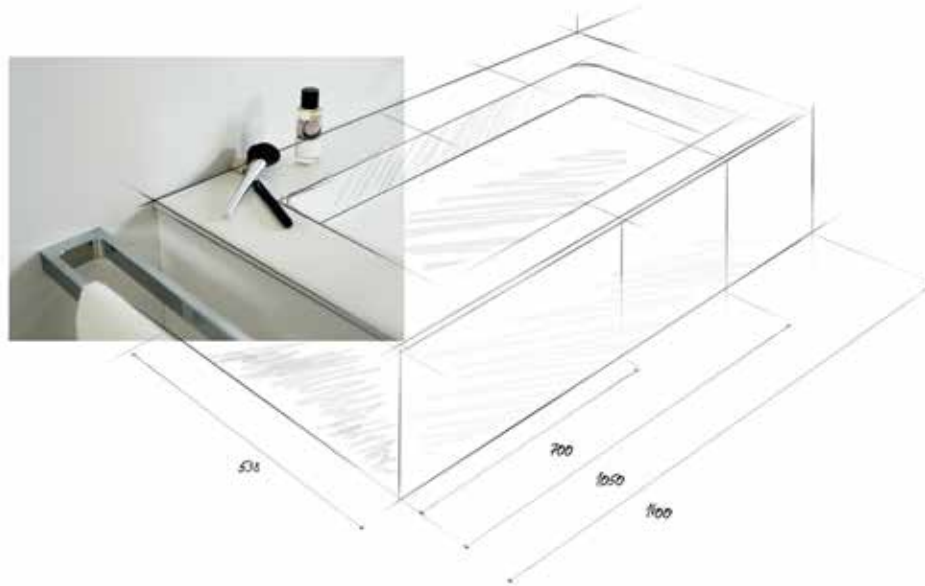

EDITION 11 – The innovative furnishing concept offers a linear design and soft forms, multiplied by an enormous range of variations. For lovers of consistently thought-through designs the ROYAL 60 washbasin represents the perfect complement to the mirror cabinets and bathroom furniture of EDITION 11. In classic, rectangular form, the most convincing thing about the ceramic washbasin both inside and out is its precise, high quality workmanship and flat design. With its generous shelf space all round in the three sizes of 700, 1050 and 1400 mm, it offers individual and creative planning potential for bathrooms of any size. Together with the EDITION 11 vanity unit, which borrows from the washbasin's filigree, linear vocabulary of form, the ensemble adorns any bathroom like an extraordinary jewel.



A washbasin from the ROYAL 60 collection combined with an EDITION 11 vanity unit



# PERFECTION FROM EVERY ANGLE



The EDITION 11 mirror cabinet also offers high quality and functional features inside, with a slidable interior cosmetic mirror in addition to the rear wall mirror. In tune with the times, Bluetooth and loudspeakers offer a sound system for your favourite music.



product  
winner



reddot design award  
winner 2012



# GENEROSITY IN LIMITED SPACE

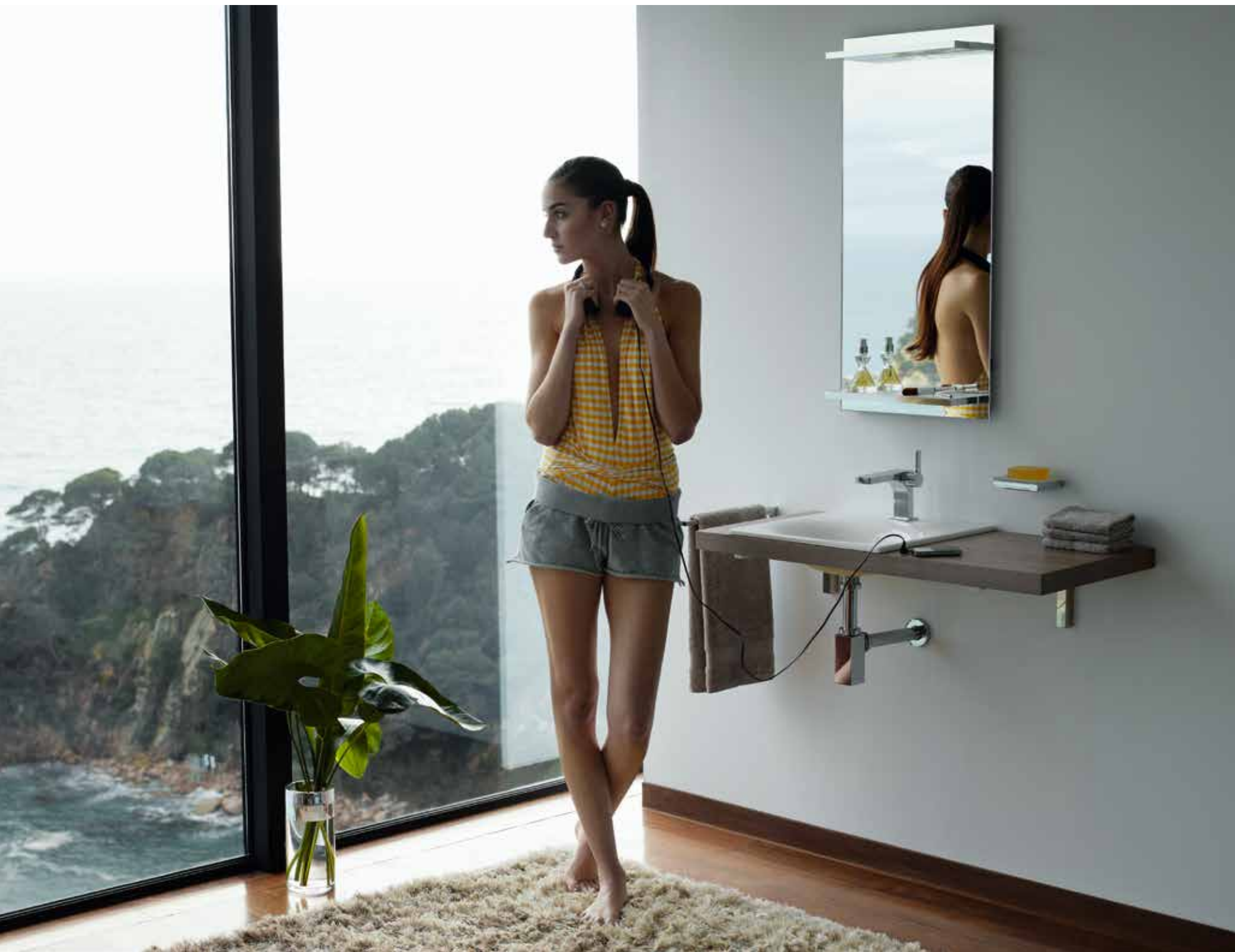

A host's attitude towards guests is shown not least in the bathroom made available to them. Therefore EDITION 11 also presents well-coordinated, impressive furnishings, compatible with each other and a representative guest bathroom. The elegant ceramic washbasin measuring 435 x 435 mm can be installed with a custom-made solid oak wood washtop, or can be combined with a matching vanity unit with one of the wellknown EDITION 11 surfaces. The washtop, made of solid oak wood, is available in different colours – light oak, platin oak and tabacco oak. Bespoke versions are available in widths ranging from 700 mm to 1500 mm.



The light mirror for the guest bathroom not only presents a handy, but also elegant innovation: Two LED illuminated panels, which at the same time serve the function as a shelf. Of course a proportioned fitting as well as a one or two arm towel holder matching the guest washbasin are available.





# CLEAR LINES, IMMACULATE SURFACES

The perfect chrome-plated washbasin fittings of EDITION 11 are optimally suited for every kind of use. Whether as a smaller model for the guest WC or especially high for washbasin tops and convenient hair-washing – they fulfil any wish regarding individual bathroom planning.





As with all EDITION 11 washbasin fittings, the wall fitting with single-lever mixer has a flow rate limiter. It is available with three different length spouts.



Three-hole fittings with a difference: Temperature regulation on the left, flow rate on the right. After adjusting to your own desired temperature, by pulling it up, the regulator can be returned to its initial position so that the temperature setting is retained.





The particularly appealing design of the freestanding bath tub mixer with a separate waterway for the hand shower is very impressive. A gem in the bathroom, it can be combined with numerous bath tubs and, no matter what one's personal interior design is, gives every bathroom a special touch.



Shower rail and hand shower reiterate the weightless elegance of the design of EDITION 11. In the four-hole bath-edge fitting with hand held pencil shower head the basic quadratic form of EDITION 11 is reflected in the decor disc. The bath tub mixer shines in immaculate chrome lustre, with flow and temperature regulators situated on the side.



# INNOVATIVE COMBINATION



IXMO fittings combine more functions in fewer modules. This means that the same functions can be incorporated in either more or fewer visible parts, entirely as you like it. IXMO is available with filigree, quadratic decor discs that matches the design of the EDITION 11.





# SELECTED SHAPES IN EVERY DETAIL



KEUCO's typically large variety of products offers a rich selection for attractive bathroom furnishing. For hanging up towels alone, the assortment ranges from classic double towel holders to chic one-armed towel holders and vertical guest towel holders (along with towel bins) which can hold up to six guest towels. The product range also includes an intelligent towel ring, which has an integrated spacer ensuring that damp towels can dry properly at a sufficiently ventilated distance away from the wall.





The chrome-plated shower basket comes optionally with a conveniently integrated glass squeegee. It is easy to clean, and offers generous space for soaps, shampoos, and similar. Because of its rounded form on the inner surface, the handle, with its concisely crafted edges, has an especially pleasant feel to it.



On the right: Soap holder with removable glass dish and the double tumbler holder with mouth-blown tumblers made of crystal glass.







# CLEAR LINES AND SENSUAL FEELING

The freestanding accessories of EDITION 11 radiate power and size and embody sense and sensuality with their high-quality matte porcelain. The unglazed porcelain is individually produced in a complex and meticulous process in Meissen. In total there are four porcelain accessories to choose from. They exert their special appeal in the bathroom when combined together: A soap foam dispenser, a universal pot, a tissue dispenser and an elegant dish.





EDITION 300

# CHARACTER INSTEAD OF INDIFFERENCE



# A STRIKING, ERGONOMICALLY THOUGHT-THROUGH DESIGN



KEUCO design is determined by aesthetics, functionality and ergonomics, not by the kind of logic that characterizes mass production. The fittings and accessories of EDITION 300 clearly exemplify this philosophy and make it something to be experienced. Convenience of use coupled with striking elegance. The brilliance of the perfectly worked surface emphasizes the characteristic contours.



reddot design award  
winner 2006

Tesseraux+Partner  
Dominik Tesseraux



# FLEXIBILITY FROM ITS MOST BEAUTIFUL SIDE



Uncompromising in bathroom planning: For everything you envisage EDITION 300 has a matching product for you. You can choose between wall, single-hole and triple-hole washbasin fittings; between light mirrors and mirror cabinets, and between different dimensions and surface combinations. All according to our motto: The more freedom there is in planning, the longer the enjoyment in use. When opening, the drawers of the vanity units slide without a sound. Their dividers offer you intelligently organized storage space in which your body-care utensils won't get mixed up.





# LASTING IMPRESSIONS FOR SHORT STAYS



The guest WC is a special calling card in every house. With its impressive functionality and stylish elegance, EDITION 300 is ideally equipped to leave an excellent impression with your guests. With the small, only slightly projecting washbasin size it's possible to design even guest WCs with much charm. Even the towel holder and the vanity unit with front drawer and integrated towel opening offer much comfort for small rooms.

# CONSISTENT COMBINATION MADE EASY



At KEUCO accessories are much more than just useful additions. It is also important that they can be blended in any combination to form a harmonious visual whole, perfectly coordinated to the characteristic design of the rest of the bathroom furnishings. EDITION 300 does this beautifully.







ROYAL 60

LINEAR, PURE  
AND SIMPLE

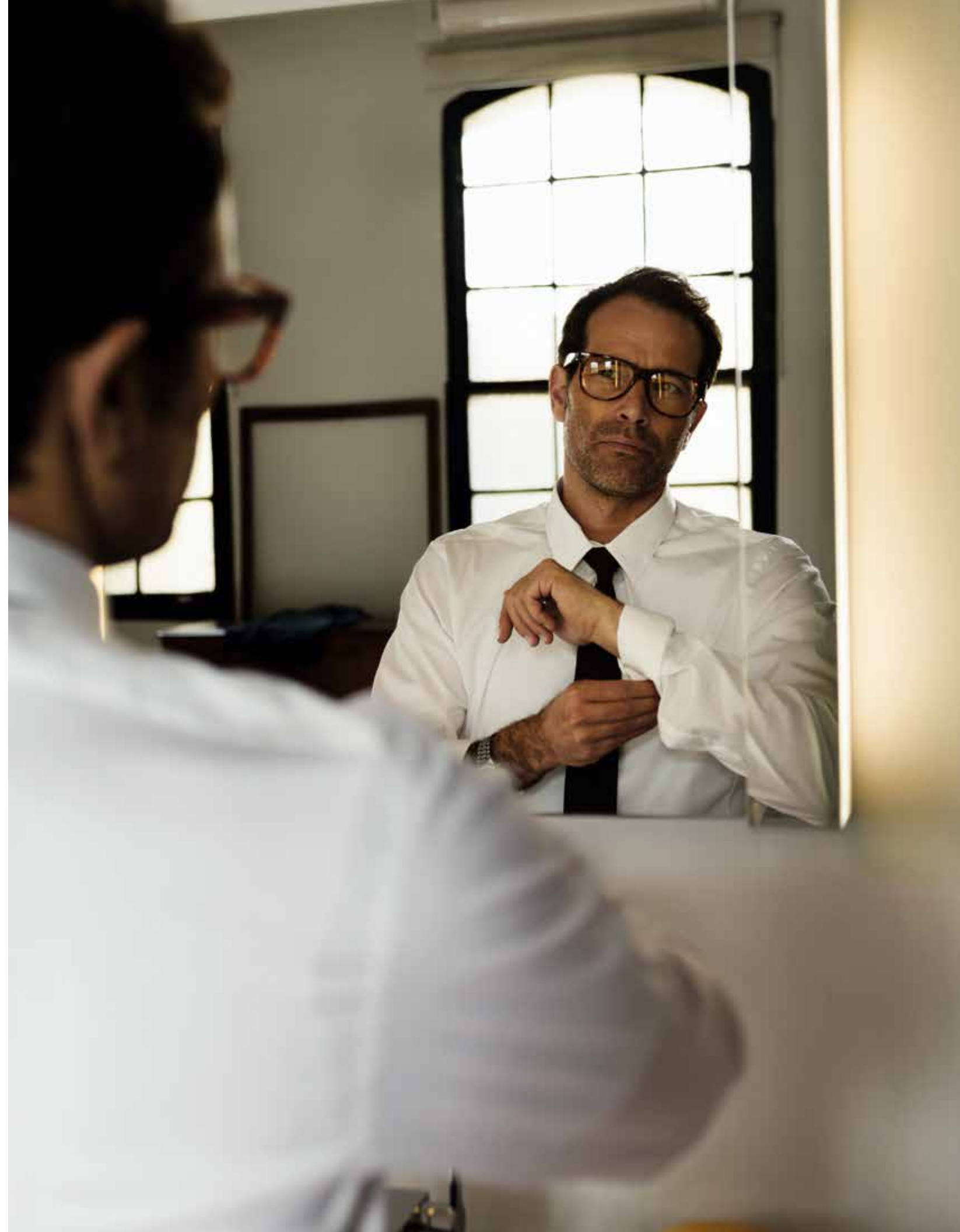



# ARCHITECTURALLY ORIENTATED INTERIOR DESIGN



Clear, linear and minimalist – that is the new concept of KEUCO's ROYAL 60 collection. The sleek design, so full of lightness, comes to the fore thanks to its restraint – for your own personal vision of modern bathroom design. Its formal reduction creates calmness and accentuates the geometry of the room. This design relies on understatement that is beyond time and fashion trends. ROYAL 60 – the bathroom concept for minimalist aesthetes.

Basin mixer and accessories EDITION 11



Tesseraux+Partner  
Dominik Tesseraux





# LINEAR, SLENDER AND CONTEMPORARY



Basin mixer and accessories EDITION 11

The furnishing concept ROYAL 60 from KEUCO presents itself with clarity and purity. Bathroom furniture and washbasins of the ROYAL 60 collection adhere to a linear language of form, and offer great combination potential. The rectangular washbasin with generous shelf space all round is available as single or double washbasin. For lovers of soft forms the EDITION 11 washbasin with its softly rolling lines is the ideal addition, thanks to the same width sizes of 700, 1050 and 1400 mm. Its unobtrusiveness brings the slender, exceedingly lightweight design to the forefront. The various EDITION 11 accessories and fittings are the perfect addition: Regardless whether you choose a single-lever basin mixer, a three-hole basin mixer or wall fitting. Combining with the fittings and accessories of EDITION 300 opens up a huge variety of possibilities in bathroom architecture too.



Stylish combination: ROYAL 60 vanity unit with EDITION 11 washbasin



Basin mixer and accessories EDITION 300







The inside of the vanity unit also has an impressive amount of storage space and a flexible system of dividers. The superior quality solid beech wood boxes inside the pull-out guarantee the best of order. The boxes prevent items stored inside from falling when opening or closing the drawer and can be adjusted or removed depending on personal needs; this gives the possibility of putting them where you need your bathroom utensils.



# FULLY THOUGHT-THROUGH STYLE-ICONS



The architecturally orientated collection also offers a wide selection of products relating to light and mirrors. Besides attractive illuminated mirrors and mirror cabinets for plenty of storage space ROYAL 60 provides a further highlight: A built-in mirror cabinet with side lighting with clear and linear design. Installed concise with the wall, it is that "certain something" of upscale interior design. Of course the interior of the cabinet is equipped with the typical KEUCO comfort: Complete interior rear wall mirrored, sockets and many more features.





sun  
café



ROYAL REFLEX

# THE SUBJECT OF GLASS REDISCOVERED FOR THE BATHROOM

Basin mixer PLAN blue, accessories PLAN





# HYGIENIC, ROBUST, PERFECT

Even over the decades glass with a lacquered underside still loses none of its brilliance and its colour intensity. Because of the way it reflects light it adds a special atmosphere to every bathroom. ROYAL REFLEX is always an eye-catcher – whether in strong, powerful tones or in discreet colours. Consisting of washbasins, bathroom furniture, light mirrors and mirror cabinets, this furnishing concept leaves no wish ungranted.



.moll design  
Reiner Möll

Single lever bath tub mixer PLAN, basin mixer and lotion dispenser ELEGANCE



# PERFECT WORKMANSHIP, INTELLIGENT DETAILS



Basin mixer and lotion dispenser ELEGANCE

Our passion for detail makes daily use of ROYAL REFLEX a pleasure not only in terms of aesthetics, but also functionality. Contained behind the gently gliding front drawers with handles on the sides is a sophisticated storage system in which every bathroom utensil finds a suitable place. Intelligent storage details: The hanging wooden box is slidable and easy to take out. The dividers fixed by magnets on the base of the front drawer can be positioned as you desire.







A light, floating overall feeling of classical modernity is created by clear lines and reflected light. The wide range of surfaces and body variations adapt individually to a variety of living styles. Different materials in beautiful harmony: Lustred glass front and matt body; on top of this a cast mineral washbasin. Perfectly coordinated with this: The handle on the side in anodized aluminium.

Basin mixer PLAN blue, accessories PLAN

# LOTS OF ROOM IN A SMALL SPACE



Basin mixer PLAN blue, accessories PLAN

With its perfect dimensions ROYAL REFLEX adds elegance and generosity even to small guest WCs. The vanity unit with buffer, door left or right hand hinged, creates storage space even in a small area.



Basin mixer PLAN blue, accessories PLAN



# ONE INDIVIDUAL SIGNATURE, MANY FORMATS



If glass is so important, then mirrors are indispensable. ROYAL REFLEX offers mirror cabinets and light mirrors in customary, outstanding KEUCO quality – matching all sizes from the double washbasin right down to compact models for the guest WC.

Unobtrusive elegance: Just as with the mirror cabinets, the light mirrors are also available in all six washbasin sizes. The mirror is framed on both sides by the vertical lighting. Glass shelves behind doors with mirrors on both sides offer plenty of storage space. Two interior electric sockets and one exterior light switch provide perfect functionality.



Basin mixer and lotion dispenser ELEGANCE

ROYAL UNIVERSE

# THE ESSENCE OF HARMONIOUS DESIGN







# LANGUAGE OF FORM WITH CHARACTER



With its ROYAL UNIVERSE washbasin and furniture collection, KEUCO is enhancing its coveted mirror cabinet range of the same name, design and size. In this design, the designer, Reiner Moll has continued the attributes of the series. The high quality workmanship of the ceramic washbasins reflects the essence of design: Clear lines, soft corner radii and smoothly rounded edges summarize a consistent overall picture. The design of ROYAL UNIVERSE combines harmoniously with the fittings and accessories of KEUCO's COLLECTION MOLL or PLAN blue and PLAN. In the style of a modern classic, they underscore the design of the ROYAL UNIVERSE series perfectly.



Basin mixer PLAN blue, accessories PLAN

.molldesign  
Reiner Moll



# FREEDOM TO DECIDE WITH ELEGANCE

The wide range of ROYAL UNIVERSE wash-basins, with widths from 500 mm to a twin washbasin of 1300 mm, provides the right solution for every bathroom – from the small guest bathroom to the large family bathroom. The elegantly shaped ceramic washbasin looks both delicate and elegant. With its wide edges, it also offers a lot of storage space – particularly ideal for small bathrooms. Anyone with enough room and the need for additional storage space can complement the vanity unit with a tall, middle or base unit. The flexible system of dividers in the vanity unit offers a good overview and tidiness.



Basin mixer and accessories COLLECTION MOLL



Basin mixer and accessories COLLECTION MOLL



Basin mixer and accessories COLLECTION MOLL







Glass, not like any other material, is suitable for use in the bathroom. The glass fronts of ROYAL UNIVERSE are made of robust safety glass, hygienic and particularly easy to clean. Glass surfaces, with the rear of the glass matt lacquered in the latest colours, are very much in keeping with the trend of the times and give the bathroom a special touch, radiating peace and comfort. Those who prefer a more brilliant look can choose a variant in high gloss white.



# BEAUTY MEETS INNOVATION



As a practical utensil for daily beauty care, the glare-free iLook\_move cosmetic mirror shines with its slender, refined design in round or square form, with illuminated or unilluminated mirror surface. The hinge technology works brilliantly too: The height, distance, inclination and lateral angle can each be adjusted with a simple action. In the illuminated model with control panel on the glass surface, this innovative mirror with fivefold magnification designed by Tesseraux+Partner offers two different light modes: A daylight function, like the ones that can be found in professional beauty institutes, and a second luminous colour in flattering warm white – ideal for the perfect evening makeup, for example. Unique to date is the infinitely variable adjustment feature of both luminous colours.

Whether with a luminous colour or a control panel on the glass surface with sensor system, the iLook\_move is simultaneously high tech for beauty care and a perfect masterpiece. The LED lamp is long-lasting and has minimal power consumption. If flush-mounted fitting is not an option, a version is also available with a wall wart. More detailed information about the iLook\_move cosmetic mirror can be found in our catalogue "Mirror cabinets, light mirrors and cosmetic mirrors".







WE'RE PASSIONATE  
ABOUT FLAWLESS  
PRODUCTS



# PRODUCT OVERVIEW



31570



31580



31198



31140



31150



31160



32140



32150



32160

**31570**  
**Ceramic built-in washbasin**  
no tap hole, without overflow  
with CleanPlus surface  
Dimensions (w x h x d):  
600 x 16 x 400 mm  
600 x 75 x 400 mm

**31140**  
**Ceramic washbasin**  
with CleanPlus surface  
Variations:  
– without tap hole, without overflow drain  
– with tap hole suitable for 1-hole fittings  
or 3-hole fittings (gauge 200 mm), complete  
with CLOU drain and overflow system  
Dimensions (w x h x d): 705 x 17 x 538 mm

**32140**  
**Ceramic washbasin**  
with CleanPlus surface  
Variations:  
– without tap hole, without overflow drain  
– with tap hole suitable for 1-hole fittings  
or 3-hole fittings (gauge 200 mm),  
complete with CLOU drain and overflow system  
Dimensions (w x h x d): 705 x 17 x 538 mm

**31580**  
**Ceramic built-in washbasin**  
no tap hole, without overflow  
with CleanPlus surface  
Dimensions (w x h x d):  
800 x 16 x 400 mm  
800 x 75 x 400 mm

**31150**  
**Ceramic washbasin**  
with CleanPlus surface  
Variations:  
– without tap hole, without overflow drain  
– with tap hole suitable for 1-hole fittings  
or 3-hole fittings (gauge 200 mm),  
complete with CLOU drain and overflow system  
Dimensions (w x h x d): 1055 x 17 x 538 mm

**32150**  
**Ceramic washbasin**  
with CleanPlus surface  
Variations:  
– without tap hole, without overflow drain  
– with tap hole suitable for 1-hole fittings  
or 3-hole fittings (gauge 200 mm),  
complete with CLOU drain and overflow system  
Dimensions (w x h x d): 1055 x 17 x 538 mm

**31198**  
**Ceramic washbasin**  
with CleanPlus surface,  
without overflow drain,  
as desired without tap hole or  
with tap hole for 1-hole fittings  
Dimensions (w x h x d): 438 x 12 x 438 mm

**31160**  
**Ceramic washbasin/double washbasin**  
with CleanPlus surface  
Variations:  
– without tap hole, without overflow drain  
– with tap hole suitable for 1-hole fittings  
or 3-hole fittings (gauge 200 mm),  
complete with CLOU drain and overflow system  
Dimensions (w x h x d): 1405 x 17 x 538 mm

**32160**  
**Ceramic washbasin/double washbasin**  
with CleanPlus surface  
Variations:  
– without tap hole, without overflow drain  
– with tap hole suitable for 1-hole fittings  
or 3-hole fittings (gauge 200 mm),  
complete with CLOU drain and overflow system  
Dimensions (w x h x d): 1405 x 17 x 538 mm





31541



31551



31561



31562



31752



31571



31572



31573



31574



31740



31741



31753



31598



31582



31583



31575



31742



31743



31760



31750



31751



31761

**31541/31571/31598**

**Vanity unit**  
 Variations:  
 – no tap hole  
 – with tap hole, compatible with ceramic washbasin  
 Article No. 31570  
 – compatible with ceramic washbasin  
 Article No. 31140/32140/31198  
 2 drawer fronts with push-to-open mechanism  
 and soft closing  
 Dimensions (w x h x d):  
 700 x 546 x 450/535 mm

**31551/31572/31582**

**Vanity unit**  
 Variations:  
 – no tap hole  
 – with tap hole, compatible with ceramic washbasin  
 Article No. 31570/31580  
 – compatible with ceramic washbasin  
 Article No. 31150/32150  
 2 drawer fronts with push-to-open mechanism  
 and soft closing  
 Dimensions (w x h x d):  
 1050 x 546 x 450/535 mm

**31561/31573/31583**

**Vanity unit**  
 Variations:  
 – no tap hole  
 – with tap hole, compatible with ceramic washbasin  
 Article No. 31570/31580  
 – compatible with ceramic washbasin  
 Article No. 31160/32160  
 2 drawer fronts with push-to-open mechanism  
 and soft closing  
 Dimensions (w x h x d):  
 1400 x 546 x 450/535 mm

**31562/31574/31575**

**Vanity unit**  
 Variations:  
 – no tap hole  
 – with tap hole, compatible with 2 ceramic  
 washbasins Article No. 31570/31580  
 – compatible with ceramic washbasin  
 Article No. 31160/32160  
 2/4 drawer fronts with push-to-open mechanism  
 and soft closing  
 Dimensions (w x h x d):  
 1400 x 546 x 450/535 mm

**31740/31741**

**Side unit**  
 wall mounted  
 1 drawer front with push-to-open mechanism  
 and soft closing  
 Dimensions (w x h x d):  
 700 x 199 x 450/535 mm  
 700 x 289 x 450/535 mm

**31742/31743**

**Side unit**  
**wall mounted**  
 2 drawer fronts with push-to-open mechanism  
 and soft closing  
 Dimensions (w x h x d):  
 700 x 382 x 450/535 mm  
 700 x 472 x 450/535 mm

**31750/31751**

**Side unit**  
 wall mounted  
 1 drawer front with push-to-open mechanism  
 and soft closing  
 Dimensions (w x h x d):  
 1050 x 199 x 450/535 mm  
 1050 x 289 x 450/535 mm

**31752/31753**

**Side unit**  
 wall mounted  
 2 drawer fronts with push-to-open mechanism  
 and soft closing  
 Dimensions (w x h x d):  
 1050 x 382 x 450/535 mm  
 1050 x 472 x 450/535 mm

**31760/31761**

**Side unit**  
 wall mounted  
 1 drawer front with push-to-open mechanism  
 and soft closing  
 Dimensions (w x h x d):  
 1400 x 199 x 450/535 mm  
 1400 x 289 x 450/535 mm



31762



31763



31764



31765



31766



31767



31770



31771



31772



31773



31749/31759/31769/31779



31720



31725



31730



31735

**31762/31763/31764/31765****Side unit**

wall mounted  
2 drawer fronts with push-to-open mechanism  
and soft closing  
Dimensions (w x h x d):  
1400 x 199 x 450/535 mm  
1400 x 289 x 450/535 mm  
1400 x 382 x 450/535 mm  
1400 x 472 x 450/535 mm

**31766/31767****Side unit**

wall mounted  
4 drawer fronts with push-to-open mechanism  
and soft closing  
Dimensions (w x h x d):  
1400 x 382 x 450/535 mm  
1400 x 472 x 450/535 mm

**31770/31771****Side unit**

wall mounted  
2 drawer fronts with push-to-open mechanism  
and soft closing  
Dimensions (w x h x d):  
2100 x 199 x 450/535 mm  
2100 x 289 x 450/535 mm

**31772/31773****Side unit**

wall mounted  
4 drawer fronts with push-to-open mechanism  
and soft closing  
Dimensions (w x h x d):  
2100 x 382 x 450/535 mm  
2100 x 472 x 450/535 mm

For the floor standing version is also a  
plinth package necessary.

**31749/31759/31769/31779****Plinth package**

to combine with sideboard, wall-mounted,  
consisting of plinth panel and height adjustable  
case legs  
Dimensions (w x h x d):  
Abmessung (B x H x T):  
676 x 25 x 399/484 mm  
676 x 25 x 399/484 mm  
676 x 25 x 399/484 mm  
676 x 25 x 399/484 mm

**31720/31725****Middle unit**

single door with push-to-open mechanism  
and soft closing  
door hinge optionally left or right  
Interior fittings:  
– 2 glass shelves  
or  
– 2 glass shelves  
– 4 storage boxes  
Dimensions (w x h x d):  
350 x 894 x 300 mm  
450 x 894 x 300 mm

**31730/31735****Tall unit**

single door with push-to-open mechanism  
and soft closing  
door hinge optionally left or right  
Interior fittings:  
– 4 glass shelves  
or  
– 4 glass shelves  
– 7 storage boxes  
Dimensions (w x h x d):  
350 x 1769 x 300 mm  
450 x 1769 x 300 mm



**Custom-made washbasin board**

The board is available in depths of 535 mm and 450 mm. It is custom-made in a 1 cm raster in widths of 700–2100 mm.

Compatible with ceramic washbasins of EDITION 400, EDITION 11 and ROYAL 60 in various sizes and tap hole versions.

Alternatively to be combined with the base cabinet module:

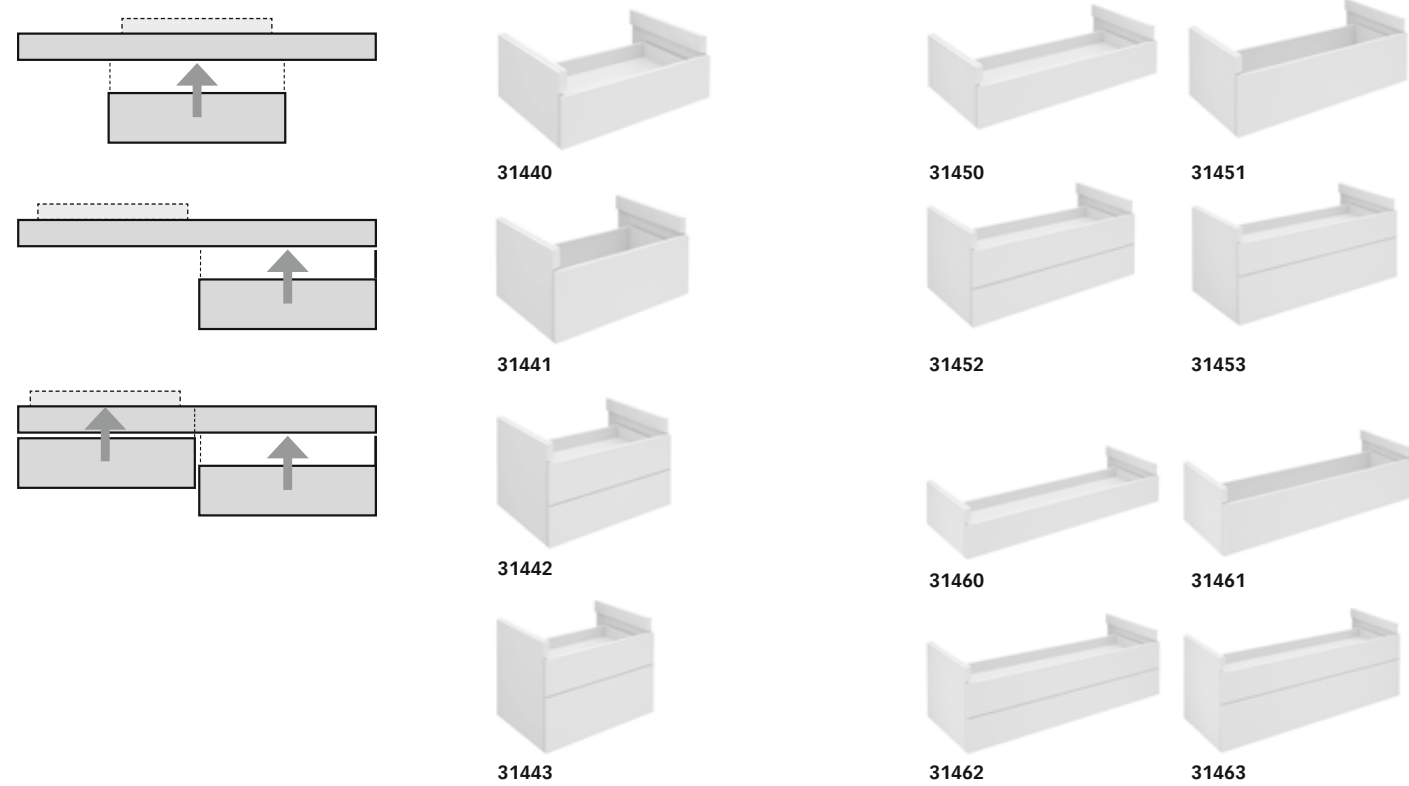

**31440/31441/31442/31443**

**Base cabinet module**

Variations:

- with/without cut-out for washbasin
- 1/2 drawer fronts with push-to-open mechanism and soft closing

Dimensions (w x h x d):  
 700 x 254 x 450/535 mm  
 700 x 344 x 450/535 mm  
 700 x 437 x 450/535 mm  
 700 x 527 x 450/535 mm

**31450/31451/31452/31453**

**Base cabinet module**

Variations:

- with/without cut-out for washbasin
- 1/2 drawer fronts with push-to-open mechanism and soft closing

Dimensions (w x h x d):  
 1050 x 254 x 450/535 mm  
 1050 x 344 x 450/535 mm  
 1050 x 437 x 450/535 mm  
 1050 x 527 x 450/535 mm

**31460/31461/31462/31463**

**Base cabinet module**

Variations:

- with/without cut-out for washbasin
- 1/2 drawer fronts with push-to-open mechanism and soft closing

Dimensions (w x h x d):  
 1400 x 254 x 450/535 mm  
 1400 x 344 x 450/535 mm  
 1400 x 437 x 450/535 mm  
 1400 x 527 x 450/535 mm

**BODY AND FRONT / BOARD  
STRUCTURED LACQUER**

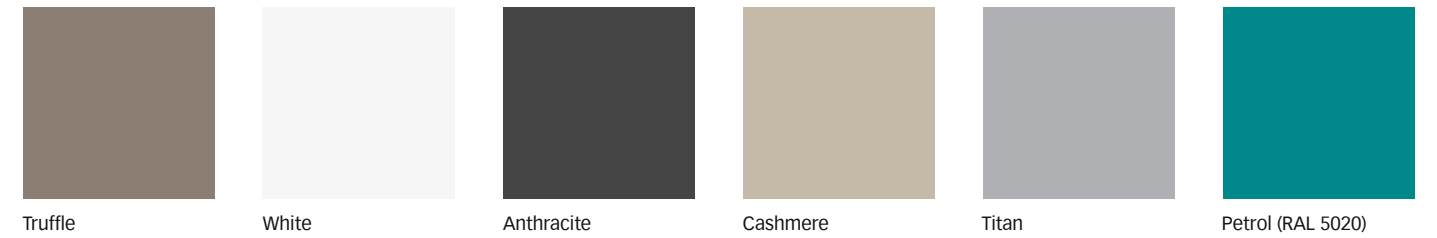

**BODY AND FRONT / BOARD  
VENEER**



**BODY AND FRONT / BOARD  
HIGH-GLOSS LACQUER**

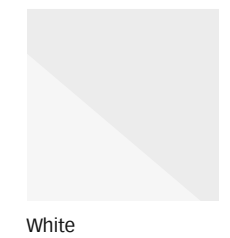

**BODY AND FRONT / BOARD STRUCTURED LACQUER  
SHELF INCLUDING 6 MM GLASS COVER PLATE HIGH-GLOSS**

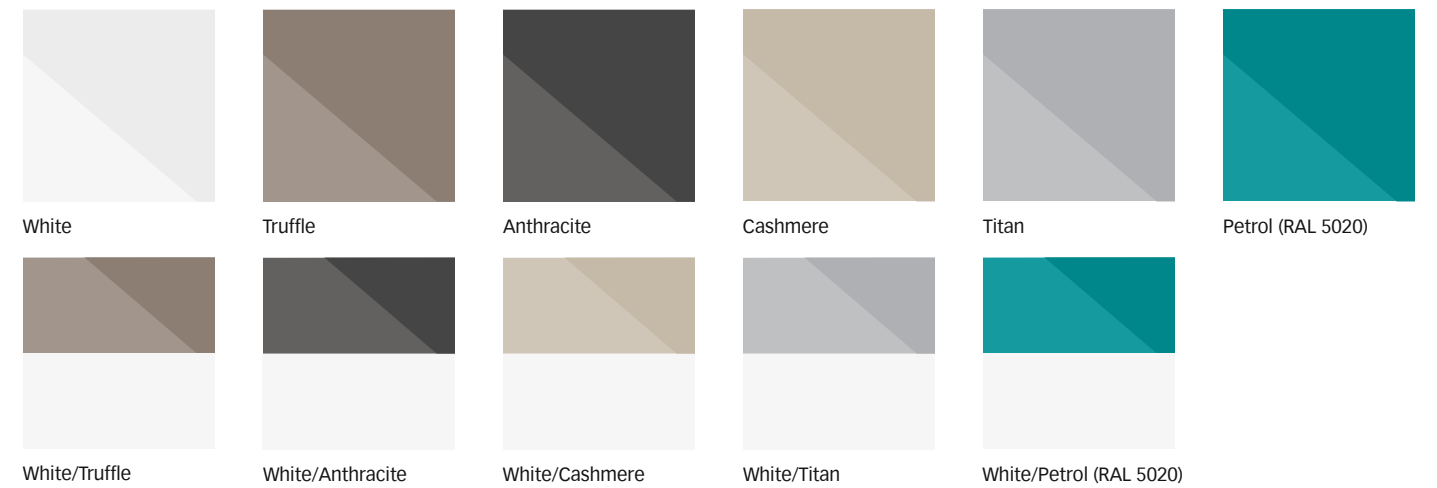

**BODY AND FRONT / BOARD STRUCTURED LACQUER  
SHELF INCLUDING 6 MM GLASS COVER PLATE MATT**





51508



51504



51504



51502



51502



51502



51505



51509



51515



51516



51520



51524



51530



51530



51545

**51508****Pillar tap 80**

without pop-up waste,  
1-hole installation, lever head action 90°  
with ceramic sealing gaskets,  
aerator SLIM SSR M 24x1, adjustable flow angle,  
flow rate limited to 7,6 l/min.

**51502****Single lever basin mixer 150**

with/without pop-up waste 1 1/4 Inch,  
1-hole installation, cartridge mixer  
with ceramic sealing gaskets,  
aerator SLIM SSR M 24x1,  
adjustable flow angle,  
flow rate limited to 7,6 l/min.

**51505****Single lever basin mixer 150**

with/without pop-up waste 1 1/4 Inch,  
spout swivelling +/- 45°,  
1-hole installation, cartridge mixer  
with ceramic sealing gaskets,  
aerator SLIM SSR M 24x1, adjustable flow angle,  
flow rate limited to 7,6 l/min.

**51504****Single lever basin mixer 80**

with/without pop-up waste 1 1/4 Inch,  
1-hole installation, cartridge mixer  
with ceramic sealing gaskets,  
aerator SLIM SSR M 24x1, adjustable flow angle,  
flow rate limited to 7,6 l/min.

**51502****Single lever basin mixer 240**

with/without pop-up waste 1 1/4 Inch,  
1-hole installation, cartridge mixer  
with ceramic sealing gaskets,  
aerator SLIM SSR M 24x1,  
adjustable flow angle,  
flow rate limited to 7,6 l/min.

**51509****Single lever bidet mixer**

with pop-up waste 1 1/4 Inch,  
1-hole installation, cartridge mixer  
with ceramic sealing gaskets,  
aerator cache TT M 18,5x1  
flow rate limited to 7,6 l/min.

**51504****Single lever basin mixer 120**

with/without pop-up waste 1 1/4 Inch,  
1-hole installation, cartridge mixer  
with ceramic sealing gaskets,  
aerator SLIM SSR M 24x1, adjustable flow angle,  
flow rate limited to 7,6 l/min.

**51502****Single lever basin mixer 290**

without pop-up waste,  
1-hole installation, cartridge mixer  
with ceramic sealing gaskets,  
aerator SLIM SSR M 24x1,  
adjustable flow angle,  
flow rate limited to 7,6 l/min.

**51515****Three-hole basin mixer 150**

with/without pop-up waste 1 1/4 Inch,  
3-hole installation, ceramic valve for temperature  
regulation and valve for flow control,  
aerator SLIM SSR M 24x1, adjustable flow angle,  
flow rate limited to 7,6 l/min.

**51516****Single lever basin mixer**

concealed fitting DN 15,  
cartridge mixer with ceramic sealing gaskets  
and temperature control,  
aerator SLIM SSR M 24x1, adjustable flow angle,  
flow rate limited to 7,6 l/min.  
Projection: 187, 219, 265 mm  
(essential for installation:  
Rough part Article No. 59916  
to be ordered separately)

**Note:**

flexible arrangement of lever and spout possible  
during assembly.

**51530****Bath tub mixer**

4-hole bath filler,  
ceramic valve for temperature regulation  
and valve for flow control,  
aerator SLIM SSR M 24x1, adjustable flow angle,  
pull-out pencil hand shower,  
with backflow preventer  
Projection: 180, 220 mm  
(suitable fixing block Article No. 51130  
to be ordered separately)

**51520****Single lever bath tub mixer**

exposed,  
cartridge mixer with ceramic sealing gaskets,  
with automatic diverter, aerator SLIM SSR M 24x1,  
adjustable flow angle, with backflow preventer

**51530****Bath tub mixer**

3-hole bath filler,  
ceramic valve for temperature regulation  
and valve for flow control,  
pull-out pencil hand shower,  
with backflow preventer,  
(suitable fixing block Article No. 51130  
to be ordered separately)

**51524****Single lever shower mixer**

exposed,  
cartridge mixer with ceramic sealing gaskets,  
with backflow preventer

**51545****Bath spout DN20**

suitable for all concealed fittings  
Projection: 152, 202 mm





51571



51572



51572



51573



51574



51580



56080



51585



51587

900 mm



51591



51686/51688



51686/51689



54947



54995



11596



11597



11596



11597



11195



11596



11597

**51571**  
**Single lever shower mixer**  
concealed fitting,  
set complete with: handle, sleeve, rosette  
and installation unit,  
suitable for rough part no. 59970 (Flexx Boxx)  
(Flexx Boxx to be ordered separately)

**51580**  
**Hand shower**  
with anti limescale device,  
with normal, soft and massage jet  
with ECO AIR function,  
restricted flow rate 10 l/min.

**56080**  
**Round pencil hand shower**  
with normal jet

**54947**  
**Wall outlet for shower hose DN 15**  
suitable for all concealed fittings

**54995**  
**Shower hose DN 15**  
both ends fitted with conical nut  
and twist-protection  
1250, 1600, 2000 mm

**51572**  
**Single lever bath tub and shower mixer**  
concealed fitting,  
with/without safety device,  
set complete with: handle, sleeve, diverter, rosette  
and installation unit,  
suitable for rough part no. 59970 (Flexx Boxx)  
(Flexx Boxx to be ordered separately)

**51585**  
**Hand shower sliding rail**  
consisting of:  
– wall rail, 900 mm  
– sliding bracket for hand shower  
– height adjustment via handle,  
tilting angle adjustable  
– spacer disc (5 mm)

**51587**  
**Hand shower sliding rail set**  
consisting of:  
– rail with sliding bracket, 900 mm  
– height adjustment via handle,  
tilting angle adjustable  
– spacer disc (5 mm)  
– hand shower with normal, soft and massage jet  
– shower hose, 1600 mm

**51573/51574**  
**Thermostat battery**  
concealed fitting  
with ceramic cut-off valve (51573),  
with ceramic cut-off and switch valve (51574),  
safety cut-off at 38°C,  
set complete with: handle, sleeve, diverter,  
rosette and installation unit,  
suitable for rough part no. 59970 (Flexx Boxx)  
(Flexx Boxx to be ordered separately)

**51591**  
**Wall bracket for hand shower**  
for shower hoses with conical nuts

**51686/51688**  
**Head shower with ceiling outlet DN 15**  
Ø 180 mm, with shower head rail,  
restricted flow rate 15 l/min.  
Projection: 100, 300 mm

**51686/51689**  
**Head shower with ceiling outlet DN 15**  
Ø 180 mm, with shower head rail,  
restricted flow rate 15 l/min.  
Projection: 100, 300 mm

**11195**  
**Crystal mirror**  
Dimensions (w x h x d):  
535 x 610 x 26 mm  
700 x 610 x 26 mm  
1050 x 610 x 26 mm  
1400 x 610 x 26 mm  
1750 x 610 x 26 mm  
2100 x 610 x 26 mm

**11496**  
**Light mirror customized**  
Features as 11596  
Dimensions (w x h x d):  
720–2110 x 650 x 33 mm

**11596**  
**Light mirror**  
adjustable light colour from 2700 kelvin (warm white)  
to 6500 kelvin (daylight),  
continuous aluminium frame,  
optionally with mirror heating  
Operation:  
key panel with capacitive touch sensor,  
integrated extension function for e.g. light switch  
Illumination:  
LED, infinitely variable dimming  
Dimensions (w x h x d):  
535 x 650 x 33 mm  
710 x 650 x 33 mm  
1060 x 650 x 33 mm  
1410 x 650 x 33 mm

**11497**  
**Light mirror customized**  
Features as 11597  
Dimensions (w x h x d):  
720–2110 x 650 x 33 mm

**11597**  
**Light mirror**  
1 light colour, 4000 kelvin (neutral white)  
continuous aluminium frame  
Operation:  
key panel with capacitive touch sensor,  
optionally to be operated via the light switch  
Illumination:  
LED, infinitely variable dimming  
Dimensions (w x h x d):  
535 x 650 x 33 mm  
710 x 650 x 33 mm  
1060 x 650 x 33 mm  
1410 x 650 x 33 mm



21501/21521



21511/21531



21502/21522



21512/21532



21503/21523



21513/21533

**21501/21502/21503**

**21521/21522/21523**

**Mirror cabinet**

for recessed or non-recessed mounting,  
adjustable light colour from 2700 kelvin (warm white)  
to 6500 kelvin (daylight),  
2/3 hinged double sided crystal mirrored doors

Body: aluminium silver anodized, interior rear wall mirrored

Operation:

key panel with capacitive touch sensor,  
integrated extension function for e.g. light switch

Illumination:

LED, infinitely variable dimming

Features:

- 2 sockets
- 3/2 x 3 adjustable glass shelves
- 1/2 storage boxes with slidable glass lid
- interior lighting
- soft-closing doors

Dimensions (w x h x d):

- 710 x 650 x 154 mm (depth in front of the wall 24 mm / 167 mm)
- 1060 x 650 x 154 mm (depth in front of the wall 24 mm / 167 mm)
- 1410 x 650 x 154 mm (depth in front of the wall 24 mm / 167 mm)

**21511/21512/21513**

**21531/21532/21533**

**Mirror cabinet**

for recessed or non-recessed mounting,  
1 light colour, 4000 kelvin (neutral white),  
2/3 hinged double sided crystal mirrored doors

Body: aluminium silver anodized, interior rear wall mirrored

Operation:

key panel with capacitive touch sensor,  
optionally to be operated via the light switch

Illumination:

LED, infinitely variable dimming

Features:

- 2 sockets
- 3/2 x 3 adjustable glass shelves
- 1/2 storage boxes with slidable glass lid
- interior lighting
- soft-closing doors

Dimensions (w x h x d):

- 710 x 650 x 154 mm (depth in front of the wall 24 mm / 167 mm)
- 1060 x 650 x 154 mm (depth in front of the wall 24 mm / 167 mm)
- 1410 x 650 x 154 mm (depth in front of the wall 24 mm / 167 mm)



11501



11507



11514



11515



11518/11519



11520/11522



11521

**11501**

**Towel rail**

600, 800, 1000 mm

**11507**

**Grab bar/Towel rail (USA)**

350 mm

**11514**

**Towel hook**

60 mm

**11515**

**Towel hook**

double

**11521**

**Towel ring**





11510



11549



11550



11552



11555



11558



11559



11553



11554



11556



11562



11563



11564

**11550  
Tumbler holder**  
complete with crystal glass tumbler

**11553  
Double holder glass/lotiondispenser**  
complete, comes with:  
1 x crystal glass tumbler  
1 x lotiondispenser for liquid soap  
Capacity: approx. 150 ml

**11510  
Shelf**  
with crystalline glass shelf  
Dimensions:  
700 x 120 mm  
1050 x 120 mm  
1400 x 120 mm

**11552  
Lotion dispenser**  
complete with crystal glass tumbler, matt  
Capacity: approx. 150 ml

**11554  
Double holder glass/utensil tray**  
complete, comes with:  
1 x crystal glass tumbler  
1 x utensil tray, crystal glass matt

**11549  
Utensil tray**  
crystal glass matt

**11555  
Soap holder**  
complete with crystal glass dish, matt

**11556  
Double holder glass/soap**  
complete, comes with:  
1 x crystal glass tumbler  
1 x crystal soap dish, matt

**11558  
Shower shelf**  
aluminium silver-anodized (E6 EV1)

**11562  
Toilet paper holder**  
open form,  
for 120 mm wide paper rolls

**11559  
Shower shelf**  
aluminium silver-anodized (E6 EV1)  
with integrated glass scraper (white)

**11563  
Spare paper holder**

**11564  
Toilet brush set**  
complete with crystal glass insert matt,  
detachable opaque synthetic insert,  
brush with handle and lid, spare brush head

## SINGLE LEVER MIXER



### 1 WATER DRAW-OFF POINT

Wall outlet for shower hose



Wall outlet for shower hose with hand shower bracket



### 2 WATER DRAW-OFF POINTS

2-way diverter valve



2-way diverter valve with wall outlet for shower hose



2-way diverter valve with wall outlet for shower hose and hand shower bracket



### 3 WATER DRAW-OFF POINTS

3-way diverter valve



3-way diverter valve with wall outlet for shower hose



3-way diverter valve with wall outlet for shower hose and hand shower bracket



## THERMOSTAT



### 1 WATER DRAW-OFF POINT

Stop valve



Stop valve with wall outlet for shower hose



Stop valve with wall outlet for shower hose and hand shower bracket



### 2 WATER DRAW-OFF POINTS

2-way diverter valve



2-way diverter valve with wall outlet for shower hose



2-way diverter valve with wall outlet for shower hose and hand shower bracket



2-way stop and diverter valve



2-way stop and diverter valve with wall outlet for shower hose



2-way stop and diverter valve with wall outlet for shower hose and hand shower bracket



### 3 WATER DRAW-OFF POINTS

3-way diverter valve



3-way diverter valve with wall outlet for shower hose



3-way diverter valve with wall outlet for shower hose and hand shower bracket



3-way stop and diverter valve



3-way stop and diverter valve with wall outlet for shower hose



3-way stop and diverter valve with wall outlet for shower hose and hand shower bracket







**59551**  
**Single lever mixer DN 15**  
Mixing cartridge with ceramic sealing gaskets, temperature controlled, set complete with:  
handle, sleeve, rosette (round or square) and installation unit,  
suitable for rough part no. 59551/000070



**59551**  
**Installation unit for single lever mixer DN 15**  
Rough part for recessed installation



**59553**  
**Thermostat battery DN 15**  
Set complete with:  
handle, sleeve and rosette (round or square)  
suitable for rough part no. 59553/000070



**59553**  
**Installation unit for thermostat battery DN 15**  
Rough part for recessed installation



**59556**  
**2-way diverter valve DN 15**  
Set complete with:  
handle, casing, rosette (round or square) and diverter valve  
suitable for rough part no. 59556/000070



**59556**  
**Installation unit for 2-way diverter valve DN 15**  
Rough part for recessed installation



**59547**  
**Wall outlet for shower hose DN 15**  
with round or square decorative disc,  
intrinsically safe against backflow  
Projection: 55 mm



**59556**  
**2-way diverter valve with wall outlet for shower hose DN 15**  
Set complete with:  
handle, casing, rosette (round or square) and diverter valve,  
intrinsically safe against backflow,  
suitable for rough part no. 59556/000170



**59556**  
**Installation unit for 2-way diverter valve with wall outlet for shower hose DN 15**  
Rough part for recessed installation



**59592**  
**Wall outlet for shower hose with hand shower bracket DN 15**  
for shower hoses with fitted conical end brackets,  
with round or square decorative disc,  
intrinsically safe against backflow



**59556**  
**2-way diverter valve with wall outlet for shower hose and hand shower bracket DN 15**  
Set complete with:  
handle, casing, rosette (round or square) and diverter valve,  
intrinsically safe against backflow,  
suitable for rough part no. 59556/000170



**59556**  
**Installation unit for 2-way diverter valve with wall outlet for shower hose DN 15**  
Rough part for recessed installation



**59541**  
**Stop valve DN 15**  
Set complete with:  
handle, casing, rosette (round or square) and stop cock  
suitable for rough part no. 59541/000070



**59541**  
**Installation unit for stop valve DN 15**  
Rough part for recessed installation



**59557**  
**2-way stop and diverter valve DN 15**  
Set complete with:  
handle, casing, rosette (round or square) and stop and diverter valve  
suitable for rough part no. 59556/000070



**59556**  
**Installation unit for 2-way diverter valve DN 15**  
Rough part for recessed installation



**59541**  
**Stop valve with wall outlet for shower hose DN 15**  
Set complete with:  
handle, casing, rosette (round or square) and stop cock,  
intrinsically safe against backflow,  
suitable for rough part no. 59541/000170



**59541**  
**Installation unit for stop valve with wall outlet for shower hose DN 15**  
Rough part for recessed installation



**59557**  
**2-way stop and diverter valve with wall outlet for shower hose DN 15**  
Set complete with:  
handle, casing, rosette (round or square) and stop and diverter valve,  
intrinsically safe against backflow,  
suitable for rough part no. 59556/000170



**59556**  
**Installation unit for 2-way diverter valve with wall outlet for shower hose DN 15**  
Rough part for recessed installation



**59541**  
**Stop valve with wall outlet for shower hose and hand shower bracket DN 15**  
Set complete with:  
handle, casing, rosette (round or square) and stop cock,  
intrinsically safe against backflow,  
suitable for stop cock no. 59541/000170



**59541**  
**Installation unit for stop valve with wall outlet for shower hose DN 15**  
Rough part for recessed installation



**59557**  
**2-way stop and diverter valve with wall outlet for shower hose and hand shower bracket DN 15**  
Set complete with:  
handle, casing, rosette (round or square) and stop and diverter valve,  
intrinsically safe against backflow,  
suitable for rough part no. 59556/000170



**59556**  
**Installation unit for 2-way diverter valve with wall outlet for shower hose DN 15**  
Rough part for recessed installation



**59548**  
**3-way diverter valve DN 15**  
Set complete with:  
handle, casing, rosette (round or square) and diverter valve  
suitable for rough part no. 59548/000070



**59548**  
**Installation unit for**  
**3-way diverter valve DN 15**  
Rough part for recessed installation



**59548**  
**3-way diverter valve with wall outlet for shower hose DN 15**  
Set complete with:  
handle, casing, rosette (round or square) and diverter valve,  
intrinsicly safe against backflow,  
suitable for rough part no. 59548/000170



**59548**  
**Installation unit for**  
**3-way diverter valve with wall**  
**outlet for shower hose DN 15**  
Rough part for recessed installation



**59548**  
**3-way diverter valve with wall outlet for shower hose**  
**and hand shower bracket DN 15**  
Set complete with:  
handle, casing, rosette (round or square) and diverter valve,  
intrinsicly safe against backflow,  
suitable for rough part no. 59548/000170



**59548**  
**Installation unit for**  
**3-way diverter valve with wall**  
**outlet for shower hose DN 15**  
Rough part for recessed installation



**59549**  
**3-way stop and diverter valve DN 15**  
Set complete with:  
handle, casing, rosette (round or square) and stop and diverter valve  
suitable for rough part no. 59548/000070



**59548**  
**Installation unit for**  
**3-way diverter valve DN 15**  
Rough part for recessed installation



**59549**  
**3-way stop and diverter valve with wall outlet**  
**for shower hose DN 15**  
Set complete with:  
handle, casing, rosette (round or square) and stop and diverter valve,  
intrinsicly safe against backflow,  
suitable for rough part no. 59548/000170



**59548**  
**Installation unit for**  
**3-way diverter valve with wall**  
**outlet for shower hose DN 15**  
Rough part for recessed installation



**59549**  
**3-way stop and diverter valve with wall outlet for shower hose**  
**and hand shower bracket DN 15**  
Set complete with:  
handle, casing, rosette (round or square) and stop and diverter valve,  
intrinsicly safe against backflow,  
suitable for rough part no. 59548/000170



**59548**  
**Installation unit for**  
**3-way diverter valve with wall**  
**outlet for shower hose DN 15**  
Rough part for recessed installation



EDITION 11



EDITION 400



ELEGANCE



PLAN



EDITION 300



COLLECTION MOLL



PLAN Blue



59541 / 59556 / 59557 / 59548 / 59549



59545

**59551**  
**Single lever mixer / handles**  
handles matching the recessed  
single lever mixers no. 59551/019501,  
59551/019502

**Handle IXMO Comfort Plus**  
for all stop and diverter valves,  
with adjustment facilities for  
twisted recessed wall installation  
of the basic unit

**59545**  
**Bath filler/spout DN 15**  
with round or square rosette,  
suitable for all concealed fittings  
Projection: 130, 180 mm

**59541** – for stop valves  
**59556** – for 2-way diverter valves  
**59557** – for 2-way stop and diverter valves  
**59548** – for 3-way diverter valves  
**59549** – for 3-way stop and diverter valves

**Note:**  
for the vertical alignment of the handle





59547

**59547**  
**Universal installation unit G 1/2**  
 for an easy fitting of products with 1/2 inch connection in combination with mounting rail, internal thread G 1/2

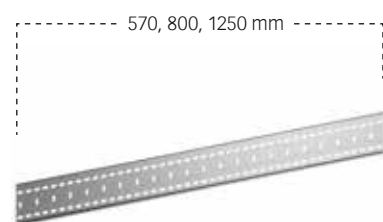

59570

**59570**  
**IXMO Mounting rail**  
 for an easy and steplessly adjustable installation of the IXMO function units  
 Length: 570, 800, 1250 mm



59553

**59553**  
**Extension rosette**  
 25 mm, round or square, brass, for installation between tiles and finish set for installation of stop and diverter valve in walls with a low wall thickness, installation depth 55-80 mm, suitable for rough part art. no. 59553 000070



59551

**59551**  
**Extension rosette**  
 25 mm, round or square, brass, for installation between tiles and finish set for installation of stop and diverter valve in walls with a low wall thickness, installation depth 55-80 mm, suitable for rough part art. no. 59541/000070, 59541/000170, 59548/000070, 59548/000170, 59556/000070, 59556/000170

**59551**  
**Extension rosette**  
 25 mm, round or square, brass, with red/blue marker, for installation between tiles and finish set for installation of stop and diverter valve in walls with a low wall thickness, installation depth 55-80 mm, suitable for rough part art. no. 59556/000070



59949

**59949**  
**Tube interrupter**  
 in accordance with DIN EN 1717 in a wall mounting box with chrome-plated cover (round)

**Note:**  
 Behind the tube interrupter is no shutoff allowed. Installation only in a vertical position.

**59949**  
**Cover cap**  
 round (90 mm Ø) or square (90 x 90 mm), for tube interrupter article no. 59949/000070

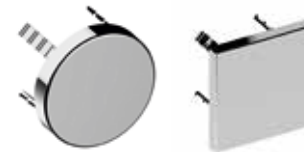

59949



59551

**59551**  
**Extension set for single lever mixer**  
 30 mm (installation depth 110-140 mm), for base structure 59551/000070

**59556**  
**Extension set for stop and diverter valve**  
 30 mm (installation depth 110-140 mm), for base structure 59541/000070, 59556/000070, 59548/000070



59556



59553

**59553**  
**Extension set for thermostatic mixer**  
 30 mm (installation depth 110-140 mm), for base structure 59553/000070



59556

**59556**  
**Extension set for stop and diverter valve with wall outlet for shower hose**  
 30 mm (installation depth 110-140 mm), for base structure 59541/000170, 59556/000170, 59548/000170



51102



51102



51104



51120



51127



51126



51109



51115



51116



51130



51130



51145

**51102**  
**Single lever basin mixer 150**  
with/without pop-up waste 1 1/4 Inch,  
1-hole installation, cartridge mixer  
with ceramic sealing gaskets  
aerator SLIM SSR M 24 x 1  
adjustable flow angle +/- 8°  
Flow rate limited to 7,6 l/min.

**51102**  
**Single lever basin mixer 250**  
without pop-up waste,  
1-hole installation, cartridge mixer  
with ceramic sealing gaskets  
aerator SLIM SSR M 24 x 1  
adjustable flow angle +/- 8°  
Flow rate limited to 7,6 l/min.

**51104**  
**Single lever basin mixer 110**  
with/without pop-up waste 1 1/4 Inch,  
1-hole installation, cartridge mixer  
with ceramic sealing gaskets  
aerator SLIM SSR M 24 x 1  
adjustable flow angle +/- 8°  
Flow rate limited to 7,6 l/min.

**51120**  
**Single lever bath tub mixer**  
exposed fitting  
shut-off valve and diverter with ceramic sealing  
gaskets, mixing valve with ceramic sealing gaskets,  
wall bracket for shower hose DN 15  
(Flow rate limited to 12 l/min.)  
with backflow preventer  
depth gauge 150 +/- 14 mm  
aerator M 28 x 1  
flow rate approx. 23 l/min.

**51127**  
**Single lever bath tub mixer**  
floor-mounted/free standing  
cartridge mixer with ceramic sealing gaskets,  
complete with round pencil shower  
and shower hose, 1250 mm  
(Floor-mounting set article no. 51127 to  
be ordered separately)

**51126**  
**Thermostat battery for shower**  
exposed fitting  
handle with 50% water consumption regulation,  
safety cut-off at 38°C,  
with backflow preventer

**51109**  
**Single lever bidet mixer**  
with pop-up waste 1 1/4 Inch,  
1-hole installation, cartridge mixer  
with ceramic sealing gaskets,  
aerator cache TT M 18,5 x 1  
Flow rate limited to 7,6 l/min.

**51115**  
**Three hole basin mixer 150**  
with/without pop-up waste 1 1/4 Inch,  
3-hole installation, ceramic valve for temperature  
regulation and valve for flow control  
Flow rate limited to 7,6 l/min.

**51116**  
**Single lever basin mixer**  
wall-mounted concealed fitting  
cartridge mixer with ceramic sealing  
gaskets and temperature limiter  
aerator SLIM SSR M 24 x 1  
adjustable flow angle +/- 8°  
Flow rate limited to 7,6 l/min.  
(essential for installation: rough part  
article no. 51116 to be ordered separately)

**51130**  
**Bath tub mixer**  
4-hole bath filler  
ceramic valve for temperature regulation  
and valve for flow control  
aerator M 28 x 1  
pull-out pencil hand shower  
with backflow preventer  
Projection: 180, 220 mm  
(suitable fixing block article no. 51130  
to be ordered separately)

**51130**  
**Bath tub mixer**  
3-hole bath filler  
ceramic valve for temperature regulation  
and valve for flow control  
pull-out pencil hand shower  
with backflow preventer  
(suitable fixing block article no. 51130  
to be ordered separately)

**51145**  
**Bath spout DN 20**  
suitable for all concealed fittings  
Projection: 146, 196 mm





51171



51172



51173



51174

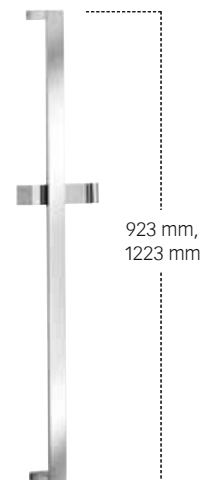

51185



51180



56080



53086/53089



53086/53088



51147



51191



51192



54941



54995

**51171**  
**Single lever shower mixer**  
 concealed fitting  
 set complete with: handle, sleeve, rosette  
 and installation unit  
 suitable for rough part no. 59970 (Flexx Boxx)  
 (Flexx Boxx to be ordered separately)

**51173**  
**Thermostat battery**  
 concealed fitting  
 with ceramic cut-off valve,  
 safety cut-off at 38 °C,  
 set complete with: handle, sleeve, diverter,  
 rosette and installation unit  
 suitable for rough part no. 59970 (Flexx Boxx)  
 (Flexx Boxx to be ordered separately)

**51172**  
**Single lever bath tub and shower mixer**  
 concealed fitting  
 with/without safety device  
 set complete with: handle, sleeve, diverter, rosette  
 and installation unit  
 suitable for rough part no. 59970 (Flexx Boxx)  
 (Flexx Boxx to be ordered separately)

**51174**  
**Thermostat battery**  
 concealed fitting  
 with ceramic cut-off and switch valve,  
 safety cut-off at 38 °C,  
 set complete with: handle, sleeve, diverter,  
 rosette and installation unit  
 suitable for rough part no. 59970 (Flexx Boxx)  
 (Flexx Boxx to be ordered separately)

**51185**  
**Hand shower sliding rail**  
 consisting of:  
 – wall rail 900, 1200 mm  
 – sliding bracket for hand shower  
 – height adjustment via handle,  
 tilting angle adjustable  
 – spacer disc (5 mm)

**51180**  
**Hand shower**  
 with anti limescale device  
 with normal jet  
 restricted flow rate 12 l/min.

**56080**  
**Round pencil hand shower**  
 with normal jet

**51147**  
**Wall outlet for shower hose DN 15**  
 suitable for all concealed fittings  
 with backflow preventer

**53086/53089**  
**Shower head with ceiling outlet DN 15**  
 with shower head rail  
 restricted flow rate 15 l/min.  
 Projection: 100, 300 mm

**51191**  
**Wall bracket for hand shower**  
 for shower hoses with conical nuts  
 usable on left or right

**51192**  
**Wall outlet for hand shower DN 15**  
 with integrated wall outlet  
 for shower hoses with conical nuts  
 suitable for all concealed fittings  
 with backflow preventer

**53086/53088**  
**Shower head with wall outlet DN 15**  
 with shower head rail  
 restricted flow rate 15 l/min.  
 Projection: 300, 450 mm

**54941**  
**Exposed part for angle valve DN 15/DN 20**  
 complete with: handle, sleeve, rosette  
 and adjustable extension  
 (Angle valve DN 15/DN 20 to be ordered separately)

**54995**  
**Shower hose DN 15**  
 both ends fitted with conical nut  
 and twist-protection  
 1250, 1600, 2000 mm

Glass colour variations

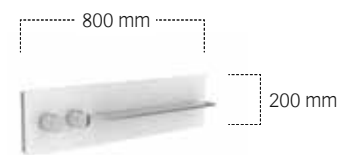
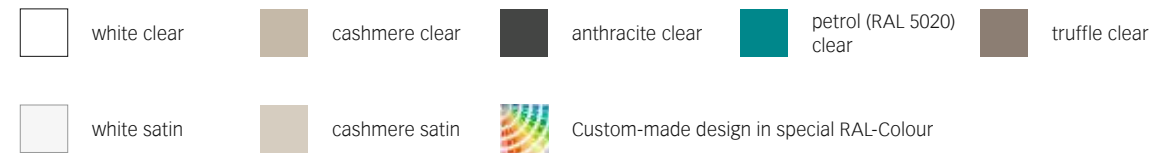

56161

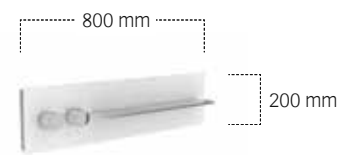

56162

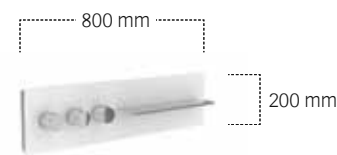

56163

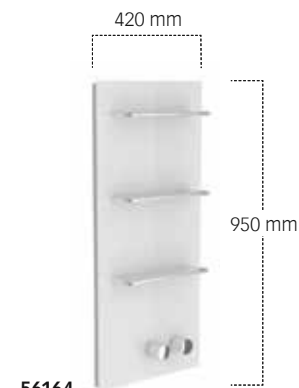

56164

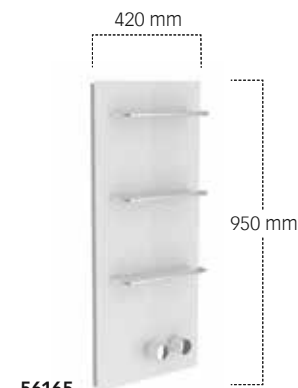

56165

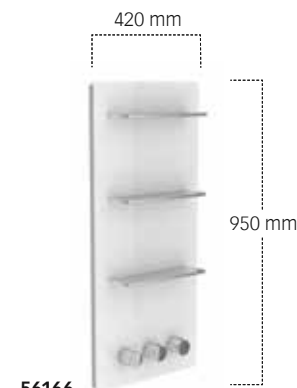

56166



59948



59982



59993



59996

**56161**  
**Shower and bathtub board with thermostat battery DN20**  
 Finish set for the regulation of 1 user handles as desired left or right complete with:  
 – Mounting frame  
 – Panel made of ESG glass, with frame and one shelf made of aluminium  
 – Knob for thermostat with safety cut-off at 38 °C  
 – Shut-off handle  
 Dimensions (w x h): 800 x 200 mm (essential for installation: rough part article no. 56161 000071 to be ordered separately)

**56164**  
**Shower board with thermostat battery DN20**  
 Finish set for the regulation of 1 user handles right, complete with:  
 – Mounting frame  
 – Panel made of ESG glass, with frame and three shelves made of aluminium  
 – Knob for thermostat with safety cut-off at 38 °C  
 – Shut-off handle  
 Dimensions (w x h): 420 x 950 mm (essential for installation: rough part article no. 56161 000071 to be ordered separately)

**56162**  
**Shower and bathtub board with thermostat battery DN20**  
 Finish set for the regulation of 2 users handles as desired left or right with/without safety device complete with:  
 – Mounting frame  
 – Panel made of ESG glass, with frame and one shelf made of aluminium  
 – Knob for thermostat with safety cut-off at 38 °C  
 – Shut-off and adjustment handle  
 Dimensions (w x h): 800 x 200 mm (essential for installation: rough part article no. 56162 000072 to be ordered separately)

**56165**  
**Shower board with thermostat battery DN20**  
 Finish set for the regulation of 2 users handles right, complete with:  
 – Mounting frame  
 – Panel made of ESG glass, with frame and three shelves made of aluminium  
 – Knob for thermostat with safety cut-off at 38 °C  
 – Shut-off and adjustment handle  
 Dimensions (w x h): 420 x 950 mm (essential for installation: rough part article no. 56162 000072 to be ordered separately)

**56163**  
**Shower and bathtub board with thermostat battery DN20**  
 Finish set for the regulation of 3 users handles as desired left or right complete with:  
 – Mounting frame  
 – Panel made of ESG glass, with frame and one shelf made of aluminium  
 – Knob for thermostat with safety cut-off at 38 °C  
 – Shut-off handle  
 – Adjustment grip  
 Dimensions (w x h): 800 x 200 mm (essential for installation: rough part article no. 56163 000073 to be ordered separately)

**56166**  
**Shower board with thermostat battery DN20**  
 Finish set for the regulation of 3 users handles right, complete with:  
 – Mounting frame  
 – Panel made of ESG glass, with frame and three shelves made of aluminium  
 – Knob for thermostat with safety cut-off at 38 °C  
 – Shut-off handle  
 – Adjustment grip  
 Dimensions (w x h): 420 x 950 mm (essential for installation: rough part article no. 56163 000073 to be ordered separately)

**59948**  
**Exposed part for 3-way diverter valve UP**  
 complete with:  
 handle, sleeve, rosette (round/square)

**59982**  
**Waterfall shower**  
 for wall connection G 1/2 Inch restricted flow rate 25 l/min.

**59993**  
**Wall outlet for shower hose DN20**  
 with wall bracket, for SPA hose, suitable for all concealed fittings with backflow preventer

**59996**  
**SPA hose**  
 with chrome-plated shower bracket for wall connection elbow and chrome-plated hose connection 3/4"





11101



11107

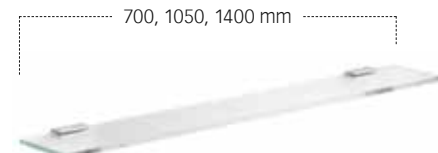

11110



11158



11159



11162

11163



11114



11115



11116



11121



11164



11150



11151



11118/11119



11120/11122



11170

11172



11152



11153



11155

**11101**  
**Towel rail**  
600, 800, 1000 mm

**11107**  
**Grab bar/Towel rail (USA)**  
300 mm

**11110**  
**Shelf**  
with crystalline glass shelf  
Dimensions (w x h):  
700 x 120 mm  
1050 x 120 mm  
1400 x 120 mm

**11158**  
**Shower basket**  
aluminium silver anodized/chrome-plated  
Dimensions (w x h x d): 300 x 95 x 67 mm

**11159**  
**Shower basket**  
aluminium silver anodized/chrome-plated  
with integrated glass scraper  
Dimensions (w x h x d): 300 x 95 x 67 mm

**11162**  
**Toilet paper holder**  
open form,  
for 120 mm wide paper rolls

**11114**  
**Towel hook**  
47 mm

**11116**  
**Robe hook**  
67 mm

**11121**  
**Towel ring**

**11164**  
**Toilet brush set**  
with crystal glass insert, matt,  
brush with handle and spare brush head

**11150**  
**Tumbler holder**  
complete with crystal glass tumbler, hand-  
blown

**11163**  
**Spare paper holder**

**11115**  
**Towel hook**  
double, 46 mm

**11120/11122**  
**Towel holder**  
1-arm, fixed  
Projection: 340, 450 mm

**11170**  
**Towel holder**  
holds 6 guest towels  
(approx. 30 x 50 cm)

**11172**  
**Guest towel basket**  
removable,  
MDF white lacquered  
Dimensions (w x h x d): 200 x 350 x 200 mm

**11152**  
**Lotion dispenser**  
complete with crystal glass, matt  
Capacity: approx. 180 ml

**11153**  
**Double holder**  
consisting of:  
– 1 x crystal glass matt, hand-blown  
– 1 x lotion dispenser (crystal glass, matt)  
complete with pump for liquid soap  
Capacity: approx. 180 ml

**11151**  
**Double tumbler holder**  
complete with crystal glasses, hand-blown

**11155**  
**Soap holder**  
complete with removable crystal glass dish



11153



11156



11169



11177

**11153**  
**Foam soap dispenser**  
standing model, porcelain  
Capacity: approx. 500 ml

**11156**  
**Porcelain dish**  
standing model, porcelain

**11169**  
**Porcelain container**  
standing model, porcelain

**11177**  
**Tissue box**  
standing model, porcelain

Expansive lines give EDITION 11 an distinctive impression. The fronts, which seem to float on the face of the furniture, give lightness and elegance to the furniture. Because the Varicor® material is especially lightweight, it is possible to create a wide range of sizes of washbasin tops.

BODY AND FRONT  
VENEER



Light oak



Oak-platinum



Oak-tobacco

BODY  
LACQUER SILK MATT/  
FRONT GLASS SATIN

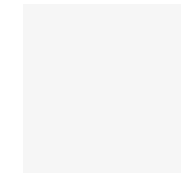

White



Cashmere

BODY  
LACQUER SILK MATT/  
FRONT GLASS



Anthracite  
(RAL 7015)



Truffle



Violet  
(RAL 4007)



Black

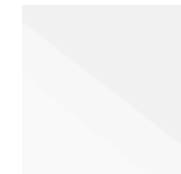

White



Cashmere

BODY AND FRONT  
STRUCTURED LACQUER



Anthracite  
(RAL 7015)



Truffle

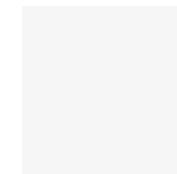

White

BODY AND FRONT  
HIGH-GLOSS LACQUER

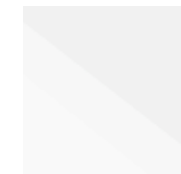

White





31140



31341



31342



31150



31351



31153/31154



31165/31166



31352



31163/31164

**31140**  
**Ceramic washbasin**  
with CleanPlus surface  
Variations:  
– without tap hole, without overflow drain  
– with tap hole suitable for 1-hole fittings  
or 3-hole fittings (gauge 200 mm), complete  
with CLOU drain and overflow system  
Dimensions (w x h x d): 705 x 17 x 538 mm

**31341**  
**Vanity unit**  
compatible with ceramic washbasin  
article no. 31140 and Varicor® washbasin  
made to measure,  
1 drawer front with push-to-open mechanism  
Interior fittings:  
– additionally with LED interior lighting,  
automatic on-off function  
Dimensions (w x h x d): 700 x 350 x 535 mm

**31153/31154**  
**Vanity unit**  
compatible with ceramic washbasin  
article no. 31140, optionally left (31153)  
or right (31154),  
1 drawer with push-to-open mechanism  
Interior fittings:  
– 1 sliding storage box (190 x 70 x 413 mm)  
– additionally with LED interior lighting,  
automatic on-off function  
Dimensions (w x h x d): 1050 x 350 x 535 mm

**31342**  
**Vanity unit**  
compatible with ceramic washbasin  
article no. 31140 and Varicor® washbasin  
made to measure,  
2 drawers with push-to-open mechanism  
Interior fittings:  
– 1 sliding storage box (190 x 70 x 413 mm)  
– additionally with LED interior lighting,  
automatic on-off function  
Dimensions (w x h x d): 700 x 700 x 535 mm

**31165/31166**  
**Vanity unit**  
compatible with ceramic washbasin  
article no. 31140, optionally left (31165)  
or right (31166),  
1 drawer with push-to-open mechanism  
Interior fittings:  
– 2 sliding storage boxes (190 x 70 x 413 mm)  
– additionally with LED interior lighting,  
automatic on-off function  
Dimensions (w x h x d): 1400 x 350 x 535 mm

**31150**  
**Ceramic washbasin**  
with CleanPlus surface  
Variations:  
– without tap hole, without overflow drain  
– with tap hole suitable for 1-hole fittings  
or 3-hole fittings (gauge 200 mm),  
complete with CLOU drain and overflow system  
Dimensions (w x h x d): 1055 x 17 x 538 mm

**31351**  
**Vanity unit**  
compatible with ceramic washbasin  
article no. 31150 and Varicor® washbasin  
made to measure,  
1 drawer with push-to-open mechanism  
Interior fittings:  
– 1 sliding storage box (190 x 70 x 413 mm)  
– additionally with LED interior lighting,  
automatic on-off function  
Dimensions (w x h x d): 1050 x 350 x 535 mm

**31352**  
**Vanity unit**  
compatible with ceramic washbasin  
article no. 31150 and Varicor® washbasin  
made to measure,  
2 drawers with push-to-open mechanism  
Interior fittings:  
– 2 sliding storage boxes (190 x 70 x 413 mm)  
– additionally with LED interior lighting,  
automatic on-off function  
Dimensions (w x h x d): 1050 x 350 x 535 mm

**31163/31164**  
**Vanity unit**  
compatible with ceramic washbasin  
article no. 31150, optionally left (31163)  
or right (31164)  
1 drawer with push-to-open mechanism  
Interior fittings:  
– 2 sliding storage boxes (190 x 70 x 413 mm)  
– additionally with LED interior lighting,  
automatic on-off function  
Dimensions (w x h x d): 1400 x 350 x 535 mm



31160



31361



31362

**31160**  
**Ceramic washbasin / double washbasin**  
 with CleanPlus surface  
 Variations:  
 – without tap hole, without overflow drain  
 – with tap hole suitable for 1-hole fittings or 3-hole fittings (gauge 200 mm), complete with CLOU drain and overflow system  
 Dimensions (w x h x d): 1405 x 17 x 538 mm

**31361**  
**Vanity unit**  
 compatible with ceramic washbasin article no. 31160 and Varicor® washbasin made to measure,  
 1 drawer with push-to-open mechanism  
 Interior fittings:  
 – 2 sliding storage boxes (190 x 70 x 413 mm)  
 – additionally with LED interior lighting, automatic on-off function  
 Dimensions (w x h x d): 1400 x 350 x 535 mm

**31362**  
**Vanity unit**  
 compatible with ceramic washbasin article no. 31160 and Varicor® washbasin made to measure,  
 2 drawers with push-to-open mechanism  
 Interior fittings:  
 – 4 sliding storage boxes (190 x 70 x 413 mm)  
 – additionally with LED interior lighting, automatic on-off function  
 Dimensions (w x h x d): 1400 x 700 x 535 mm

VANITY UNIT WITH VARICOR® WASHBASIN

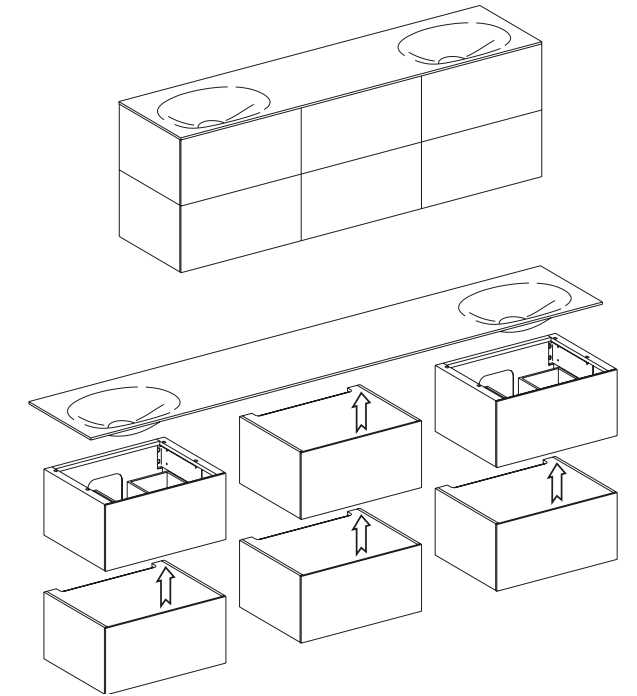
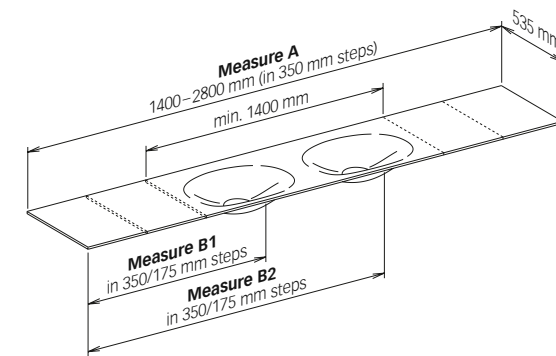
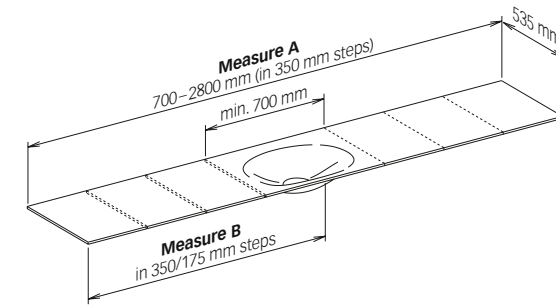

Varicor® washbasins are made to measure in widths of 700 – 2800 mm, and can be combined as single or double washbasin, with or without tap hole, with the various options of vanity unit and modular base cabinet.

	Washbasins 700 – 2800 mm made to measure with variable washbasin bowl				
<b>Vanity units</b>					
<b>700 mm</b>					
<b>1050 mm</b>					
<b>1400 mm</b>					
<b>Base cabinet module</b>					
<b>350 mm</b>					
<b>700 mm</b>					
<b>1050 mm</b>					
<b>1400 mm</b>					

**Note:** The vanity unit and modular base cabinet can be installed directly beside or under one another. Here, the adjacent furniture is completely and seamlessly covered by the uninterrupted Varicor®-washbasin.

**Please note:** Ceramic washbasins of EDITION 11 can also be combined with vanity units of collection ROYAL 60.





31240



31241



31342



31270



31352



31251



31255/31256



31253/31254

**31240****Varicor® washbasin**

## Variations:

- without tap hole, without overflow drain
- with tap hole suitable for 1-hole fittings or 3-hole fittings (gauge 200 mm), complete with CLOU drain and overflow system

Dimensions (w x h x d): 700 x 17 x 535 mm

**31241****Vanity unit**

compatible with ceramic washbasin article no. 31140 and Varicor® washbasin made to measure,  
1 drawer front with push-to-open mechanism  
Interior fittings:  
– additionally with LED interior lighting, automatic on-off function  
Dimensions (w x h x d): 700 x 350 x 535 mm

**31342****Vanity unit**

compatible with ceramic washbasin article no. 31140 and Varicor® washbasin made to measure,  
2 drawers with push-to-open mechanism  
Interior fittings:  
– 1 sliding storage box (190 x 70 x 413 mm)  
– additionally with LED interior lighting, automatic on-off function  
Dimensions (w x h x d): 700 x 700 x 535 mm

**31270****Varicor® washbasin**

## Variations:

- without tap hole, without overflow drain
- with tap hole suitable for 1-hole fittings or 3-hole fittings (gauge 200 mm), complete with CLOU drain and overflow system

Dimensions (w x h x d): 1050 x 17 x 535 mm

**31251****Vanity unit**

compatible with Varicor® washbasin made to measure, for central washbasin bowl,  
1 drawer with push-to-open mechanism  
Interior fittings:  
– 1 sliding storage box (190 x 70 x 413 mm)  
– additionally with LED interior lighting, automatic on-off function  
Dimensions (w x h x d): 1050 x 350 x 535 mm

**31352****Vanity unit**

compatible with ceramic washbasin article no. 31150 and Varicor® washbasin made to measure,  
2 drawers with push-to-open mechanism  
Interior fittings:  
– 2 sliding storage boxes (190 x 70 x 413 mm)  
– additionally with LED interior lighting, automatic on-off function  
Dimensions (w x h x d): 1050 x 350 x 535 mm

**31255/31256****Vanity unit**

compatible with Varicor® washbasin made to measure, with washbasin bowl optionally left (31255) or right (31256),  
2 drawers with push-to-open mechanism  
Interior fittings:  
– 2 sliding storage boxes (190 x 70 x 413 mm)  
– additionally with LED interior lighting, automatic on-off function  
Dimensions (w x h x d): 1050 x 700 x 535 mm

**31253/31254****Vanity unit**

compatible with Varicor® washbasin made to measure, with washbasin bowl optionally left (31253) or right (31254),  
1 drawer with push-to-open mechanism  
Interior fittings:  
– 1 sliding storage box (190 x 70 x 413 mm)  
– additionally with LED interior lighting, automatic on-off function  
Dimensions (w x h x d): 1050 x 350 x 535 mm

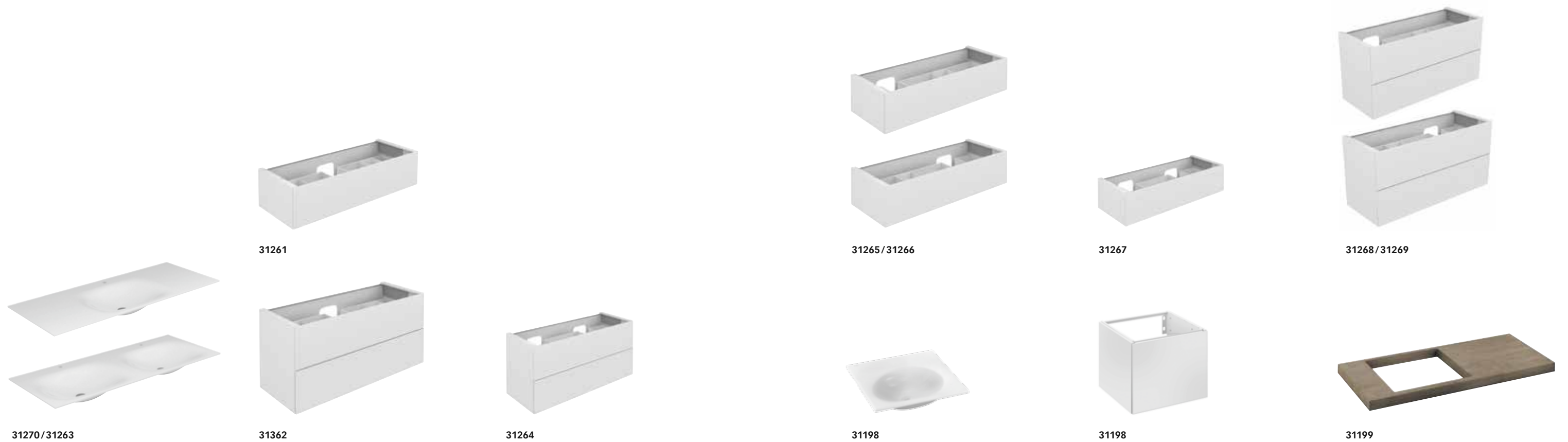

31270/31263

31261

31362

31264

31265/31266

31267

31198

31198

31268/31269

31199

**31270/31263****Varicor® washbasin / double washbasin**

## Variations:

- without tap hole, without overflow drain
- with tap hole suitable for 1-hole fittings or 3-hole fittings (gauge 200 mm), complete with CLOU drain and overflow system

Dimensions (w x h x d): 1400 x 17 x 535 mm

**31261****Vanity unit**

compatible with Varicor® washbasin made to measure, for central washbasin bowl, 1 drawer with push-to-open mechanism  
 Interior fittings:  
 – 2 sliding storage boxes (190 x 70 x 413 mm)  
 – additionally with LED interior lighting, automatic on-off function  
 Dimensions (w x h x d): 1400 x 350 x 535 mm

**31362****Vanity unit**

compatible with ceramic washbasin article no. 31160 and Varicor® washbasin made to measure, 2 drawers with push-to-open mechanism  
 Interior fittings:  
 – 4 sliding storage boxes (190 x 70 x 413 mm)  
 – additionally with LED interior lighting, automatic on-off function  
 Dimensions (w x h x d): 1400 x 700 x 535 mm

**31264****Vanity unit**

compatible with Varicor® washbasin made to measure, with double washbasin bowl, 2 drawers with push-to-open mechanism  
 Interior fittings:  
 – 2 sliding storage boxes (190 x 70 x 413 mm)  
 – additionally with LED interior lighting, automatic on-off function  
 Dimensions (w x h x d): 1400 x 700 x 535 mm

**31265/31266****Vanity unit**

compatible with Varicor® washbasin made to measure, with washbasin bowl optionally left (31265) or right (31266), 1 drawer with push-to-open mechanism  
 Interior fittings:  
 – 2 sliding storage boxes (190 x 70 x 413 mm)  
 – additionally with LED interior lighting, automatic on-off function  
 Dimensions (w x h x d): 1400 x 350 x 535 mm

**31198****Ceramic washbasin**

with CleanPlus surface, without overflow drain, as desired without tap hole or with tap hole for 1-hole fittings  
 Dimensions (w x h x d): 438 x 12 x 438 mm

**31267****Vanity unit**

compatible with Varicor® washbasin made to measure, with double washbasin bowl, 1 drawer with push-to-open mechanism  
 Interior fittings:  
 – additionally with LED interior lighting, automatic on-off function  
 Dimensions (w x h x d): 1400 x 350 x 535 mm

**31198****Vanity unit**

compatible with ceramic washbasin article no. 31198, single door, with buffer, door hinge optionally left or right  
 Dimensions (w x h x d): 496 x 450 x 347 mm

**31268/31269****Vanity unit**

compatible with Varicor® washbasin made to measure, with washbasin bowl, optionally left (31268) or right (31269), 2 drawers with push-to-open mechanism  
 Interior fittings:  
 – 4 sliding storage boxes (190 x 70 x 413 mm)  
 – additionally with LED interior lighting, automatic on-off function  
 Dimensions (w x h x d): 1400 x 700 x 535 mm

**31199****Vanity unit**

compatible with ceramic washbasin article no. 31198, includes fastening brackets  
 Dimensions:  
 700- 900 mm, includes 2 fastening brackets  
 910-1200 mm, includes 3 fastening brackets  
 1210-1500 mm, includes 4 fastening brackets



31310



31314



31311



31313



31317



31320



31315



31312



31316



31321



31322

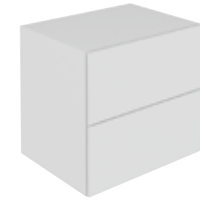

31323

**31310****Base cabinet module**

1 drawer with push-to-open mechanism  
Interior fittings:  
– additionally with LED interior lighting,  
automatic on-off function  
Dimensions (w x h x d): 350 x 350 x 535 mm

**31314****Base cabinet module**

2 drawers with push-to-open mechanism  
Interior fittings:  
– additionally with LED interior lighting,  
automatic on-off function  
Dimensions (w x h x d): 350 x 700 x 535 mm

**31311****Base cabinet module**

1 drawer with push-to-open mechanism  
Interior fittings:  
– 1 sliding storage box (190 x 70 x 413 mm)  
– additionally with LED interior lighting,  
automatic on-off function  
Dimensions (w x h x d): 700 x 350 x 535 mm

**31313****Base cabinet module**

1 drawer with push-to-open mechanism  
Interior fittings:  
– 2 sliding storage boxes (190 x 70 x 413 mm)  
– additionally with LED interior lighting,  
automatic on-off function  
Dimensions (w x h x d): 1400 x 350 x 535 mm

**31317****Base cabinet module**

2 drawers with push-to-open mechanism  
Interior fittings:  
– 4 sliding storage boxes (190 x 70 x 413 mm)  
– additionally with LED interior lighting,  
automatic on-off function  
Dimensions (w x h x d): 1400 x 700 x 535 mm

**31320****Side unit**

1 drawer with push-to-open mechanism  
Interior fittings:  
– additionally with LED interior lighting,  
automatic on-off function  
Dimensions (w x h x d): 350 x 350 x 535 mm

**31315****Base cabinet module**

2 drawers with push-to-open mechanism  
Interior fittings:  
– 2 sliding storage boxes (190 x 70 x 413 mm)  
– additionally with LED interior lighting,  
automatic on-off function  
Dimensions (w x h x d): 700 x 700 x 535 mm

**31312****Base cabinet module**

1 drawer with push-to-open mechanism  
Interior fittings:  
– 1 sliding storage box (190 x 70 x 413 mm)  
– additionally with LED interior lighting,  
automatic on-off function  
Dimensions (w x h x d): 1050 x 350 x 535 mm

**31316****Base cabinet module**

2 drawers with push-to-open mechanism  
Interior fittings:  
– 2 sliding storage boxes (190 x 70 x 413 mm)  
– additionally with LED interior lighting,  
automatic on-off function  
Dimensions (w x h x d): 1050 x 700 x 535 mm

**31321****Side unit**

2 drawers with push-to-open mechanism  
Interior fittings:  
– additionally with LED interior lighting,  
automatic on-off function  
Dimensions (w x h x d): 350 x 700 x 535 mm

**31322****Side unit**

1 drawer with push-to-open mechanism  
Interior fittings:  
– 1 sliding storage box (190 x 70 x 413 mm)  
– additionally with LED interior lighting,  
automatic on-off function  
Dimensions (w x h x d): 700 x 350 x 535 mm

**31323****Side unit**

2 drawers with push-to-open mechanism  
Interior fittings:  
– 2 sliding storage boxes (190 x 70 x 413 mm)  
– additionally with LED interior lighting,  
automatic on-off function  
Dimensions (w x h x d): 700 x 700 x 535 mm





31324



31325



31326



31327



31330/31331



11198



11195



11196



21101/21102/21103

**31324****Side unit**

1 drawer with push-to-open mechanism

Interior fittings:

- 1 sliding storage box (190 x 70 x 413 mm)
- additionally with LED interior lighting, automatic on-off function

Dimensions (w x h x d): 1050 x 350 x 535 mm

**31326****Side unit**

1 drawer with push-to-open mechanism

Interior fittings:

- 2 sliding storage boxes (190 x 70 x 413 mm)
- additionally with LED interior lighting, automatic on-off function

Dimensions (w x h x d): 1400 x 350 x 535 mm

**31325****Side unit**

2 drawers with push-to-open mechanism

Interior fittings:

- 2 sliding storage boxes (190 x 70 x 413 mm)
- additionally with LED interior lighting, automatic on-off function

Dimensions (w x h x d): 1050 x 700 x 535 mm

**31327****Side unit**

2 drawers with push-to-open mechanism

Interior fittings:

- 4 sliding storage boxes (190 x 70 x 413 mm)
- additionally with LED interior lighting, automatic on-off function

Dimensions (w x h x d): 1400 x 700 x 535 mm

**31330****Tall unit**

1 door with soft-closing

door hinge optionally left or right

Interior fittings:

- 4 glass shelves

Dimensions (w x h x d): 350 x 1700 x 370 mm

**31331****Tall unit**

1 door with soft-closing

door hinge optionally left or right

Interior fittings:

- 3 glass shelves
- 1 laundry basket
- 1 internal drawer

Dimensions (w x h x d): 350 x 1700 x 370 mm

**11198****Light mirror**

with integrated shelf,

concealed light switch

Lighting:

- LED lamps (2 x 6,5 W)

Dimensions (w x h x d): 435 x 900 x 128 mm

**11195****Crystal mirror**

Dimensions (w x h x d):

535 x 610 x 26 mm

700 x 610 x 26 mm

1050 x 610 x 26 mm

1400 x 610 x 26 mm

1750 x 610 x 26 mm

2100 x 610 x 26 mm

2450 x 610 x 26 mm

2800 x 610 x 26 mm

**11196****Light mirror**

2 laterally illuminated side wings,

each pivoting up to 90 degrees with tilting mirror,

concealed light switch

Lighting:

- fluorescent lamps (4 x 14 W T5)

Dimensions (w x h x d):

1050 x 610 x 68 mm

1400 x 610 x 68 mm

1750 x 610 x 68 mm

2100 x 610 x 68 mm

2450 x 610 x 68 mm

2800 x 610 x 68 mm

3150 x 610 x 68 mm

**21101/21102/21103****Mirror cabinet**

1 lift up door made from double-sided crystal

mirror, interior rear wall mirrored,

2 laterally illuminated side wings,

each pivoting up to 90 degrees with tilting mirror

Lighting:

- fluorescent lamps (4 x 14 W T5)

Features:

- 1 exterior light switch
- 2 interior sockets
- 1 external socket
- 1 sliding interior mirror (180 x 550 mm) with height-adjustable cosmetic mirror
- 3 height adjustable glass shelves with brackets additionally with integrated Bluetooth soundsystem

Dimensions (w x h x d):

1050 x 610 x 155 mm

1400 x 610 x 155 mm

1750 x 610 x 155 mm

**NB:** All mirror cabinets illustrated in this brochure have the German specification.

International electrical specifications on our products will vary according to individual countries' regulations and standards.



53002

**53002**  
**Single lever basin mixer 190**  
 with/without pop-up waste 1 1/4 Inch,  
 1-hole installation, cartridge mixer  
 with ceramic sealing gaskets  
 and temperature limiter  
 aerator M 21,5 x 1 cache  
 Flow rate limited to 7,6 l/min.



53004

**53004**  
**Single lever basin mixer 150**  
 without pop-up waste,  
 1-hole installation, cartridge mixer  
 with ceramic sealing gaskets  
 and temperature limiter  
 aerator M 21,5 x 1 cache  
 Flow rate limited to 7,6 l/min.



53015

**53015**  
**Three-hole basin mixer 140**  
 model with rosettes  
 with/without pop-up waste 1 1/4 Inch,  
 3-hole installation, 90° head part  
 with ceramic sealing gaskets



53030

**53030**  
**Single lever bath tub and shower mixer**  
 4-hole bath deck-mounted  
 cartridge mixer with ceramic sealing gaskets  
 and temperature limiter, with automatic diverter  
 and backflow preventer,  
 concealable hand shower with normal, soft  
 and massage jet  
 (mounting set article no. 53030 to be  
 ordered separately)



53009

**53009**  
**Single lever bidet mixer**  
 with pop-up waste 1 1/4 Inch,  
 1-hole installation, cartridge mixer  
 with ceramic sealing gaskets  
 and temperature limiter  
 aerator M 24 x 1



53030

**53030**  
**Single lever bath tub and shower mixer**  
 3-hole bath deck-mounted  
 cartridge mixer with ceramic sealing gaskets  
 and temperature limiter, with automatic diverter  
 and backflow preventer,  
 concealable hand shower with normal, soft  
 and massage jet  
 (mounting set article no. 53030 to be  
 ordered separately)



53020

**53020**  
**Single lever bath tub mixer**  
 exposed fitting  
 cartridge mixer with ceramic sealing gaskets  
 and temperature limiter, with automatic diverter,  
 with backflow preventer



53024

**53024**  
**Single lever shower mixer DN 15**  
 exposed fitting  
 cartridge mixer with ceramic sealing gaskets  
 with backflow preventer



53072

**53072**  
**Single lever bath tub and shower mixer**  
 concealed fitting  
 with/without safety device  
 set complete with: handle, sleeve, diverter,  
 rosette and installation unit  
 suitable for rough part no. 59970 (Flexx Boxx)  
 (Flexx Boxx to be ordered separately)



53071

**53071**  
**Single lever shower mixer**  
 concealed fitting  
 set complete with: handle, sleeve, rosette  
 and installation unit  
 suitable for rough part no. 59970 (Flexx Boxx)  
 (Flexx Boxx to be ordered separately)

**53045**  
**Bath filler/spout DN20**  
 suitable for all concealed fittings  
 Projection: 164, 214 mm



53045



53073

**53073/53074**  
**Thermostat battery**  
 concealed fitting  
 with ceramic cut-off valve (53073),  
 with ceramic cut-off and switch valve (53074),  
 safety cut-off at 38 °C,  
 set complete with: handle, sleeve, diverter,  
 rosette and installation unit  
 suitable for rough part no. 59970 (Flexx Boxx)  
 (Flexx Boxx to be ordered separately)



53074



53086/53088

**53086/53088**  
**Shower head with wall outlet DN 15**  
 with shower head rail  
 restricted flow rate 15 l/min.  
 Projection: 300, 450 mm



53086/53089

**53086/53089**  
**Shower head with ceiling outlet DN 15**  
 with shower head rail  
 restricted flow rate 15 l/min.  
 Projection: 100, 300 mm



53947

**53947/53047**  
**Wall outlet for shower hose DN 15**  
 suitable for all concealed fittings



53047



51147

**51147**  
**Wall outlet for shower hose DN 15**  
 suitable for all concealed fittings  
 with backflow preventer



51191

**51191**  
**Wall bracket for hand shower**  
 for shower hoses with conical nuts  
 usable on left or right



51192

**51192**  
**Wall outlet for hand shower DN 15**  
 with integrated wall outlet  
 for shower hoses with conical nuts  
 suitable for all concealed fittings  
 with backflow preventer



54941

**54941**  
**Exposed part for angle valve DN 15/DN 20**  
 complete with: handle, sleeve, rosette  
 and adjustable extension  
 (Angle valve DN 15/DN 20 to be ordered separately)



59991

**59991**  
**Wall bracket for hand shower**  
 for shower hoses with conical nuts,  
 with adjustable tilt angle 20-65°  
 Projection: 97 mm

**54991**  
**Wall bracket for hand shower**  
 for shower hoses with conical nuts





54995



54980



30010



30015



30018/30019



30007



850 mm

54985

54987

923 mm,  
1223 mm

51185

51187



30021



30050

30052



30055



30001



30063



30060



30064



30070

**54995**  
**Shower hose DN 15**  
both ends fitted with conical nut  
and twist-protection  
1250, 1600, 2000 mm

**30007**  
**Grab bar/Towel rail (USA)**  
300 mm

**30001**  
**Towel rail**  
600, 800 mm

**54980**  
**Hand shower**  
with anti limescale device  
Functions:  
– normal jet  
– soft jet  
– massage jet

**54985**  
**Hand shower sliding rail**  
consisting of:  
– wall rail, 800 mm  
– sliding bracket for shower head  
– height adjustment via handle,  
tilting angle adjustable  
– spacer disc (5 mm)

**54987**  
**Hand shower sliding rail set**  
consisting of:  
– rail with sliding bracket, 800 mm  
– height adjustment via handle,  
tilting angle adjustable  
– spacer disc (5 mm)  
– hand shower with normal, soft and massage jet  
– shower hose, 1600 mm

**51185**  
**Hand shower sliding rail**  
consisting of:  
– wall rail 900, 1200 mm  
– sliding bracket for hand shower  
– height adjustment via handle,  
tilting angle adjustable  
– spacer disc (5 mm)

**51187**  
**Hand shower sliding rail set**  
consisting of:  
– wall rail 900, 1200 mm  
– sliding bracket for hand shower  
– height adjustment via handle,  
tilting angle adjustable  
– spacer disc (5 mm)  
– hand shower with normal jet  
– shower hose, 1600 mm

**30010**  
**Shelf**  
with crystalline glass shelf, underside matt  
Dimensions (w x h):  
650 x 120 mm  
950 x 120 mm  
1250 x 120 mm

**30021**  
**Towel ring**  
Ø 210 mm  
Projection: 212 mm

**30063**  
**Spare paper holder**

**30060**  
**Toilet paper holder**  
with lid,  
for 100/120 mm wide paper rolls

**30015**  
**Towel hook**  
double

**30050**  
**Tumbler holder**  
complete with crystal glass tumbler, matt

**30052**  
**Lotion dispenser**  
complete with crystal glass tumbler, matt  
Capacity: approx. 180 ml

**30064**  
**Toilet brush set**  
complete with crystal glass insert, matt  
and brush

**30018/30019**  
**Towel holder**  
fixed  
Projection: 320, 465 mm

**30055**  
**Soap holder**  
complete with crystal glass dish, matt

**30070**  
**Towel holder**  
holds 6 guest towels  
(approx. 30 x 50 cm)

EDITION 300 has a unique character and precise geometry that lends itself to a wide variety of options, elegantly underlining the architecture of the bathroom.

BODY VENEER



Oak



Olive



Ebano



Walnut

FRONT AND BODY  
STRUCTURAL LACQUER/HIGH-GLOSS LACQUER

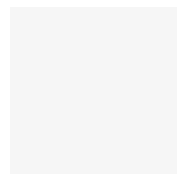

White



Sahara



Anthracite

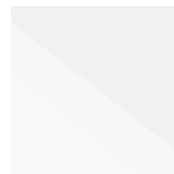

White

FRONT AND BODY  
HIGH-GLOSS LACQUER



30330



30560



30561



30331



30310/30311



30562



30332



30563

**30330**  
**Base unit**  
door hinge optionally left or right  
Interior fittings:  
– 2 glass shelves  
– 2 universal shelves  
Dimensions (w x h x d): 350 x 650 x 385 mm

**30560**  
**Cast mineral washbasin**  
with freeflow waste,  
and tap hole on the right,  
as desired also without tap hole  
Dimensions (w x h x d): 525 x 131 x 320 mm

**30561**  
**Vanity unit**  
compatible with cast mineral washbasin  
article no. 30560  
with front pull-out, as desired with/without handle,  
incl. mounting element  
Dimensions (w x h x d): 525 x 410 x 320 mm

**30331**  
**Base unit**  
door hinge optionally left or right  
Interior fittings:  
– 2 glass shelves  
– 2 universal shelves  
Dimensions (w x h x d): 500 x 650 x 385 mm

**30310**  
**Tall unit**  
door hinge optionally left or right  
Interior fittings:  
– 5 glass shelves  
– 6 universal shelves  
Dimensions (w x h x d): 350 x 1800 x 385 mm

**30562**  
**Vanity unit**  
compatible with cast mineral washbasin  
article no. 30560  
with front pull-out and towel opening on the side,  
as desired with/without handle,  
incl. mounting element  
Dimensions (w x h x d): 525 x 410 x 320 mm

**30332**  
**Base unit**  
door hinge optionally left or right  
Interior fittings:  
– 1 drawer  
– 1 laundry basket  
– 2 universal shelves  
Dimensions (w x h x d): 350 x 650 x 385 mm

**30311**  
**Tall unit**  
door hinge optionally left or right  
Interior fittings:  
– 3 glass shelves  
– 1 drawer  
– 1 laundry basket  
– 6 universal shelves  
Dimensions (w x h x d): 350 x 1800 x 385 mm

**30563**  
**Vanity unit**  
compatible with cast mineral washbasin  
article no. 30560  
opening on right, with/without handle,  
incl. mounting element  
Dimensions (w x h x d): 525 x 470 x 320 mm



30360



30380



30382/30384



30370



30371



30372/30374



30362/30364



30095



30096



30201



30096



30203



30496



30202

**30360**  
**Cast mineral washbasin**  
Variations:  
– without tap hole, with freeflow waste  
– with tap hole suitable for 1-hole fittings  
or 3-hole fittings (gauge 200/300 mm),  
complete with CLOU drain and overflow system  
Dimensions (w x h x d): 650 x 155 x 525 mm

**30370**  
**Cast mineral washbasin**  
Variations:  
– without tap hole, with freeflow waste  
– with tap hole suitable for 1-hole fittings  
or 3-hole fittings (gauge 200/300 mm),  
complete with CLOU drain and overflow system  
Dimensions (w x h x d): 1250 x 155 x 525 mm

**30380**  
**Cast mineral washbasin**  
Variations:  
– without tap hole, with freeflow waste  
– with tap hole suitable for 1-hole fittings  
or 3-hole fittings (gauge 200/300 mm),  
complete with CLOU drain and overflow system  
Dimensions (w x h x d): 950 x 155 x 525 mm

**30371**  
**Cast mineral double washbasin**  
with freeflow waste,  
as desired with tap hole for 1-hole  
or 3-hole fittings (depth gauge 200 mm)  
Dimensions (w x h x d): 1250 x 155 x 525 mm

**30362/30364**  
**Vanity unit**  
compatible with cast mineral washbasin  
article no. 30360  
as desired with 1 or 2 front pull-outs,  
incl. mounting element  
Dimensions (w x h x d): 650 x 155/315 x 525 mm

**30382/30384**  
**Vanity unit**  
compatible with cast mineral washbasin  
article no. 30380  
as desired with 1 or 2 front pull-outs,  
incl. mounting element  
Dimensions (w x h x d): 950 x 155/315 x 525 mm

**30372/30374**  
**Vanity unit**  
compatible with cast mineral washbasin  
article no. 30370 and cast mineral double washbasin  
article no. 30371  
as desired with 1 or 2 front pull-outs,  
incl. mounting element  
Dimensions (w x h x d): 1250 x 155/315 x 525 mm

**30095**  
**Crystal mirror**  
with all round facet cut  
Dimensions (w x h):  
525 x 960 mm  
650 x 650 mm  
950 x 650 mm  
1250 x 650 mm

**30096**  
**Light mirror**  
with lighting on all sides:  
– fluorescent lamps (4 x 14 W T5)  
Dimensions (w x h x d): 650 x 650 x 65 mm

**30201**  
**Mirror cabinet**  
1 lift up double-sided crystal mirror door,  
mirrored sides  
Body: aluminium, silver anodized  
Lighting:  
– fluorescent lamps (2 x 14 W T5)  
Features:  
– 1 exterior light switch  
– 2 interior electric sockets  
– 1 exterior electric socket  
– 1 adjustable interior mirror (200 x 520 mm)  
– 5 adjustable glass shelves  
Dimensions (w x h x d): 650 x 650 x 160 mm

**30096**  
**Light mirror**  
with lighting on all sides  
Fluorescent lamps/Dimensions (w x h x d):  
2 x 14 W T5 and 2 x 21 W T5/ 950 x 650 x 65 mm  
2 x 14 W T5 and 2 x 28 W T5/1250 x 650 x 65 mm

**30203**  
**Mirror cabinet**  
1 lift up double-sided crystal mirror door,  
mirrored sides  
Body: aluminium, silver anodized  
Lighting:  
– fluorescent lamps (2 x 21 W T5)  
Features:  
– 1 exterior light switch  
– 2 interior electric sockets  
– 1 exterior electric socket  
– 1 adjustable interior mirror (200 x 520 mm)  
– 5 adjustable glass shelves  
Dimensions (w x h x d): 950 x 650 x 160 mm

**30496**  
**Light mirror**  
with light switch,  
with lighting on all sides:  
– fluorescent lamps (2 x 14 W T5)  
Dimensions (w x h x d): 525 x 960 x 46 mm

**30202**  
**Mirror cabinet**  
1 lift up double-sided crystal mirror door,  
mirrored sides  
Body: aluminium, silver anodized  
Lighting:  
– fluorescent lamps (2 x 28 W T5)  
Features:  
– 1 exterior light switch  
– 2 interior electric sockets  
– 1 exterior electric socket  
– 1 adjustable interior mirror (200 x 520 mm)  
– 7 adjustable glass shelves  
Dimensions (w x h x d): 1250 x 650 x 160 mm

**NB:** All mirror cabinets illustrated in this brochure have the German specification. International electrical specifications on our products will vary according to individual countries' regulations and standards.



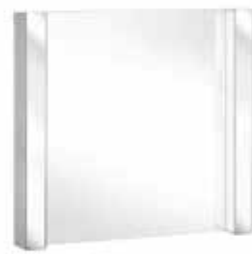

11698



11698

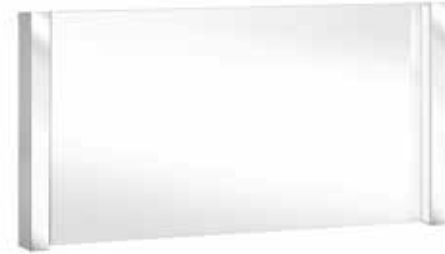

11698



22101/22111



22102/22112

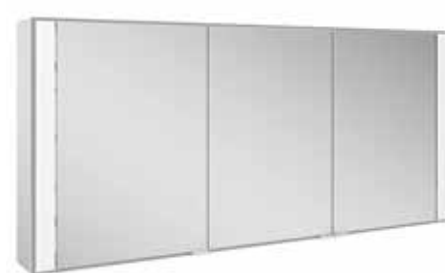

22103/22113

**11698**  
**Light mirror**  
vertical illumination, mirrored front panel, both task lighting and mood light, switched separately with concealed switches  
Lighting:  
– fluorescent lamps (4 x 14 W T5)  
Dimensions (w x h x d): 700 x 635 x 66 mm

**11698**  
**Light mirror**  
vertical illumination, mirrored front panel, both task lighting and mood light, switched separately with concealed switches  
Lighting:  
– fluorescent lamps (4 x 14 W T5)  
Dimensions (w x h x d): 1050 x 635 x 66 mm

**11698**  
**Light mirror**  
vertical illumination, mirrored front panel, both task lighting and mood light, switched separately with concealed switches  
Lighting:  
– fluorescent lamps (4 x 14 W T5)  
Dimensions (w x h x d): 1400 x 635 x 66 mm

**22101/22111**  
**Mirror cabinet**  
for wall hung (22101) or recessed mounting (22111)  
2 hinged double-sided crystal mirror doors, with buffer, interior rear wall mirrored  
Lighting:  
– fluorescent lamps (2 x 24 W T5)  
Body: aluminium, silver anodized  
Features:  
– 1 sensor switch  
– 2 shaver sockets  
– 3 height adjustable glass shelves  
Dimensions (w x h x d):  
– Non-recessed mounting: 700 x 650 x 162 mm  
– Recessed mounting: 700 x 650 x 149 mm

**22102/22112**  
**Mirror cabinet**  
for wall hung (22102) or recessed mounting (22112)  
2 hinged double-sided crystal mirror doors, with buffer, interior rear wall mirrored  
Lighting:  
– fluorescent lamps (2 x 24 W T5)  
Body: aluminium, silver anodized  
Features:  
– 1 sensor switch  
– 2 shaver sockets  
– 3 height adjustable glass shelves  
Dimensions (w x h x d):  
– Non-recessed mounting: 1050 x 650 x 162 mm  
– Recessed mounting: 1050 x 650 x 149 mm

**22103/22113**  
**Mirror cabinet**  
for wall hung (22103) or recessed mounting (22113)  
3 hinged double-sided crystal mirror doors, with buffer, interior rear wall mirrored  
Lighting:  
– fluorescent lamps (2 x 24 W T5)  
Body: aluminium, silver anodized  
Features:  
– 1 sensor switch  
– 3 shaver sockets  
– 2 x 3 height adjustable glass shelves  
Dimensions (w x h x d):  
– Non-recessed mounting: 1400 x 650 x 162 mm  
– Recessed mounting: 1400 x 650 x 149 mm



32140



32150



32160

**32140**  
**Ceramic washbasin**  
with CleanPlus surface  
Variations:  
– without tap hole, without overflow drain  
– with tap hole suitable for 1-hole fittings or 3-hole fittings (gauge 200 mm), complete with CLOU drain and overflow system  
Dimensions (w x h x d): 705 x 17 x 538 mm

**32150**  
**Ceramic washbasin**  
with CleanPlus surface  
Variations:  
– without tap hole, without overflow drain  
– with tap hole suitable for 1-hole fittings or 3-hole fittings (gauge 200 mm), complete with CLOU drain and overflow system  
Dimensions (w x h x d): 1055 x 17 x 538 mm

**32160**  
**Ceramic washbasin/double washbasin**  
with CleanPlus surface  
Variations:  
– without tap hole, without overflow drain  
– with tap hole suitable for 1-hole fittings or 3-hole fittings (gauge 200 mm), complete with CLOU drain and overflow system  
Dimensions (w x h x d): 1405 x 17 x 538 mm

ROYAL 60: We recommend brassware and accessories of EDITION 11 or EDITION 300.

**NB:** All mirror cabinets illustrated in this brochure have the German specification.

International electrical specifications on our products will vary according to individual countries' regulations and standards.

**Please note:** Ceramic washbasins of collection ROYAL 60 can also be combined with vanity units of EDITION 11

BODY AND FRONT DECOR

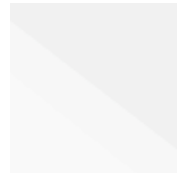

White gloss

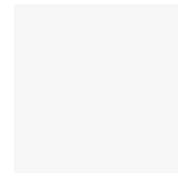

White matt



Anthracite matt



Cashmere matt



32141



32151



32161

**32141  
Vanity unit**  
compatible with ceramic washbasin  
article no. 32140,  
front pull-out with soft closing,  
incl. odour trap made of plastic  
Dimensions (w x h x d): 700 x 400 x 535 mm

**32151  
Vanity unit**  
compatible with ceramic washbasin  
article no. 32150,  
front pull-out with soft closing,  
incl. odour trap made of plastic  
Dimensions (w x h x d): 1050 x 400 x 535 mm

**32161  
Vanity unit**  
compatible with ceramic washbasin  
article no. 32160,  
front pull-out with soft closing,  
incl. odour trap made of plastic  
Dimensions (w x h x d): 1400 x 400 x 535 mm



32110



32120



32130



32131

**32110  
Base unit**  
single door, with buffer,  
door hinge optionally left or right  
Interior fittings:  
– 2 glass shelves  
Dimensions (w x h x d): 400 x 650 x 400 mm

**32120  
Middle unit**  
single door, with buffer,  
door hinge optionally left or right  
Interior fittings:  
– 2 glass shelves  
– 1 open shelf  
Dimensions (w x h x d): 400 x 1030 x 400 mm

**32130  
Tall unit**  
single door, with buffer,  
door hinge optionally left or right  
Interior fittings:  
– 5 glass shelves  
Dimensions (w x h x d): 400 x 1810 x 400 mm

**32131  
Tall unit**  
2 doors, with buffer,  
door hinge optionally left or right  
Interior fittings:  
– 3 glass shelves  
– 1 laundry basket  
Dimensions (w x h x d): 400 x 1810 x 400 mm

A perfect performance: ROYAL REFLEX sets its own unique accents in the bathroom. With every change in the lighting the glass fronts shimmer in a new and different way. The material infuses the colours with a special radiance. ROYAL REFLEX turns the bathroom into an attractive setting – and conveys a discreet sense of elegance at the same time.

BODY LACQUER SILK MATT  
FRONT GLASS

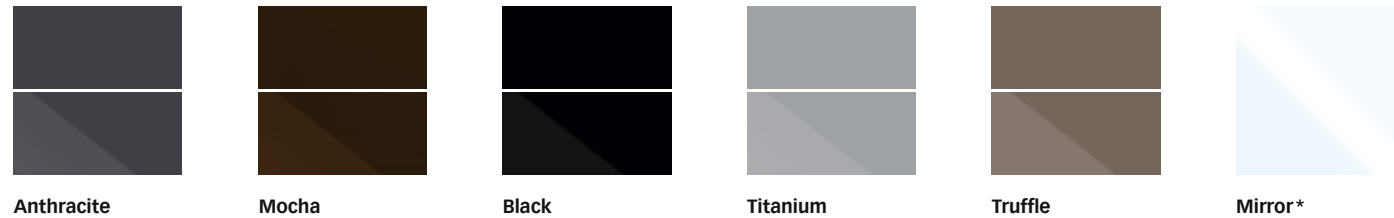

Anthracite Mocha Black Titanium Truffle Mirror\*

BODY DECOR  
FRONT GLASS

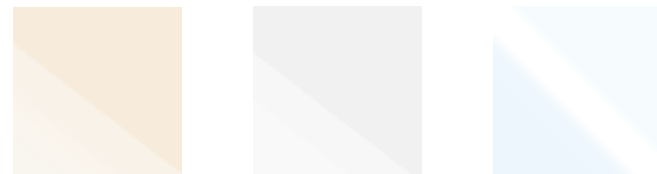

Magnolia gloss White gloss Mirror\*

\* Mirror front (only for the tall unit) combinable with all body colours  
PLEASE NOTE: Only Vanity units with lacquered backing feature horizontal, aluminium coloured decor line!



34041/34040



34091/34090



34051/34050



34061/34060



34071/34070

**34041**  
**Cast mineral washbasin**  
Variations:  
– without tap hole, without overflow drain  
– with tap hole suitable for 1-hole fittings,  
complete with CLOU drain and overflow system  
Dimensions (w x h x d): 500 x 30 x 490 mm

**34040**  
**Vanity unit**  
compatible with cast mineral washbasin  
article no. 34041, single door, with buffer,  
door hinge optionally left or right  
Dimensions (w x h x d): 496 x 450 x 487 mm

**34061**  
**Cast mineral washbasin**  
Variations:  
– without tap hole, without overflow drain  
– with tap hole suitable for 1-hole fittings,  
complete with CLOU drain and overflow system  
Dimensions (w x h x d): 800 x 30 x 490 mm

**34060**  
**Vanity unit**  
compatible with cast mineral washbasin  
article no. 34061, front pull-out with soft closing  
Interior fittings:  
– 1 storage box in solid beech wood  
(550 x 120 x 80 mm)  
– 1 plastic mat white  
Dimensions (w x h x d): 796 x 450 x 487 mm

**34091**  
**Cast mineral washbasin (Guest WC)**  
without overflow drain, variants:  
– without tap hole  
– with tap hole for 1-hole fittings  
Dimensions (w x h x d): 500 x 30 x 350 mm

**34090**  
**Vanity unit (Guest WC)**  
compatible with cast mineral washbasin  
article no. 34091, single door, with buffer,  
Dimensions (w x h x d): 496 x 450 x 347 mm

**34071**  
**Cast mineral washbasin**  
Variations:  
– without tap hole, without overflow drain  
– with tap hole suitable for 1-hole fittings  
or with tap hole suitable for 3-hole fittings  
complete with CLOU drain and overflow system  
Dimensions (w x h x d): 1000 x 30 x 490 mm

**34070**  
**Vanity unit**  
compatible with cast mineral washbasin  
article no. 34071, front pull-out with soft closing  
Interior fittings:  
– 1 storage box in solid beech wood  
(550 x 120 x 80 mm)  
– 1 plastic mat white  
Dimensions (w x h x d): 996 x 450 x 487 mm

**34051**  
**Cast mineral washbasin**  
Variations:  
– without tap hole, without overflow drain  
– with tap hole suitable for 1-hole fittings,  
complete with CLOU drain and overflow system  
Dimensions (w x h x d): 650 x 30 x 490 mm

**34050**  
**Vanity unit**  
compatible with cast mineral washbasin  
article no. 34051, front pull-out with soft closing  
Interior fittings:  
– 1 storage box in solid beech wood  
(550 x 120 x 80 mm)  
– 1 plastic mat white  
Dimensions (w x h x d): 646 x 450 x 487 mm





34081/34080



34010



34082/34080



34020



34030/34031

**34081**  
**Cast mineral washbasin**

Variations:  
– without tap hole, without overflow drain  
– with tap hole suitable for 1-hole fittings  
or with tap hole suitable for 3-hole fittings  
complete with CLOU drain and overflow system  
Dimensions (w x h x d): 1300 x 30 x 490 mm

**34082**  
**Cast mineral double washbasin**  
single tap hole, without overflow  
Dimensions (w x h x d): 1300 x 30 x 490 mm

**34080**  
**Vanity unit**  
compatible with cast mineral washbasin  
article no. 34081/34082,  
front pull-out with soft closing  
Interior fittings:  
– 2 storage boxes in solid beech wood  
(550 x 120 x 80 mm)  
– 1 plastic mat white  
Storage divider set to be ordered separately  
Dimensions (w x h x d): 1296 x 450 x 487 mm

**34010**  
**Side unit**  
front pull-out with soft closing  
crystalline glass top,  
underside white lacquered  
Dimensions (w x h x d): 800 x 370 x 335 mm

**34020**  
**Middle unit**  
single door, with buffer,  
crystalline glass top,  
underside white lacquered,  
door hinge optionally left or right  
Interior fittings:  
– 3 glass shelves  
Dimensions (w x h x d): 350 x 845 x 335 mm

**34030**  
**Tall unit**  
single door, with buffer,  
door hinge optionally left or right  
Interior fittings:  
– 4 glass shelves  
Dimensions (w x h x d): 350 x 1670 x 335 mm

**34031**  
**Tall unit**  
single door, with buffer,  
door hinge optionally left or right  
Interior fittings:  
– 3 glass shelves  
– 1 drawer  
– 1 laundry basket  
Dimensions (w x h x d): 350 x 1670 x 335 mm



24001



24002



24003



14096

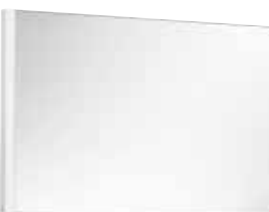

14096



24004



24005

**24001**  
**Mirror cabinet**  
1 hinged double sided crystal mirror door,  
exterior body sides mirrored,  
with buffer  
door hinge optionally left or right,  
Lighting:  
– fluorescent lamps (2 x 18 W)  
Body: aluminium, silver anodized  
Features:  
– 1 exterior light switch  
– 2 interior sockets  
– 3 adjustable glass shelves  
Dimensions (w x h x d): 500 x 700 x 150 mm

**14096**  
**Light mirror**  
vertical illumination, concealed switch,  
Lighting:  
– fluorescent lamps (2 x 21 W T5)  
Dimensions (w x h x d): 500 x 900 x 42 mm  
Lighting:  
– fluorescent lamps (2 x 24 W T5 Seamless)  
Dimensions (w x h x d):  
650 x 605 x 42 mm  
800 x 605 x 42 mm  
1000 x 605 x 42 mm  
1300 x 605 x 42 mm

**24002**  
**Mirror cabinet**  
2 hinged double sided crystal mirror doors,  
exterior body sides mirrored,  
with buffer  
Lighting:  
– fluorescent lamp (1 x 24 W T5 Seamless)  
Body: aluminium, silver anodized  
Features:  
– 1 exterior light switch  
– 2 interior sockets  
– 3 adjustable glass shelves  
Dimensions (w x h x d): 650 x 700 x 150 mm

**24004**  
**Mirror cabinet**  
3 hinged double sided crystal mirror doors,  
exterior body sides mirrored,  
with buffer  
Lighting:  
– fluorescent lamp (1 x 39 W T5 Seamless)  
Body: aluminium, silver anodized  
Features:  
– 1 exterior light switch  
– 2 interior sockets  
– 6 adjustable glass shelves  
Dimensions (w x h x d): 1000 x 700 x 150 mm

**24003**  
**Mirror cabinet**  
2 hinged double sided crystal mirror doors,  
exterior body sides mirrored,  
with buffer  
Lighting:  
– fluorescent lamps (2 x 24 W T5 Seamless)  
Body: aluminium, silver anodized  
Features:  
– 1 exterior light switch  
– 2 interior sockets  
– 3 adjustable glass shelves  
Dimensions (w x h x d): 800 x 700 x 150 mm

**24005**  
**Mirror cabinet**  
3 hinged double sided crystal mirror doors,  
exterior body sides mirrored,  
with buffer  
Lighting:  
– fluorescent lamp (1 x 54 W T5 Seamless)  
Body: aluminium, silver anodized  
Features:  
– 1 exterior light switch  
– 2 interior sockets  
– 6 adjustable glass shelves  
Dimensions (w x h x d): 1300 x 700 x 150 mm

**NB:** All mirror cabinets illustrated in this brochure have the German specification.  
International electrical specifications on our products will vary according to individual countries' regulations and standards.



32791



32751



32781



32761



32771

**32791**  
**Ceramic washbasin**  
with CleanPlus surface  
without overflow drain  
Variations:  
– without tap hole  
– with tap hole for 1-hole fittings or 3-hole fittings (gauge 200 mm),  
complete with CLOU drain and overflow system  
Dimensions (w x h x d): 505 x 16 x 355 mm

**32761**  
**Ceramic washbasin**  
with CleanPlus surface  
Variations:  
– without tap hole, without overflow drain  
– with tap hole suitable for 1-hole fittings or 3-hole fittings (gauge 200 mm),  
complete with CLOU drain and overflow system  
Dimensions (w x h x d): 805 x 16 x 495 mm

**32751**  
**Ceramic washbasin**  
with CleanPlus surface  
Variations:  
– without tap hole, without overflow drain  
– with tap hole suitable for 1-hole fittings or 3-hole fittings (gauge 200 mm),  
complete with CLOU drain and overflow system  
Dimensions (w x h x d): 655 x 16 x 495 mm

**32771**  
**Ceramic washbasin**  
with CleanPlus surface  
Variations:  
– without tap hole, without overflow drain  
– with tap hole suitable for 1-hole fittings or 3-hole fittings (gauge 200 mm),  
complete with CLOU drain and overflow system  
Dimensions (w x h x d): 1005 x 16 x 495 mm

**32781**  
**Ceramic washbasin / double washbasin**  
with CleanPlus surface  
Variations:  
– without tap hole, without overflow drain  
– with tap hole suitable for 1-hole fittings or 3-hole fittings (gauge 200 mm),  
complete with CLOU drain and overflow system  
Dimensions (w x h x d): 1305 x 16 x 495 mm

BODY DECOR  
SURFACE COATING GLOSS  
FRONT GLASS CLEAR

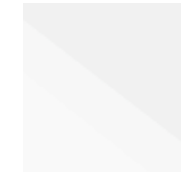

White gloss

BODY DECOR  
SURFACE COATING MATT  
FRONT GLASS SATIN

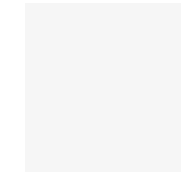

White matt



Cashmere matt

BODY LACQUER SILK MATT/  
FRONT GLASS SATIN



Anthracite matt



Titanium matt



Truffle matt



32790



32750



32760



32770



32780

**32790**  
**Vanity unit**  
compatible with ceramic washbasin  
article no. 32791,  
single door, with buffer,  
door hinge optionally left or right  
Dimensions (w x h x d): 496 x 450 x 347 mm

**32760**  
**Vanity unit**  
compatible with ceramic washbasin  
article no. 32761,  
front pull-out with soft closing,  
incl. odour trap made of plastic  
Interior fittings:  
– 1 plastic mat white  
Dimensions (w x h x d): 796 x 450 x 487 mm

**32750**  
**Vanity unit**  
compatible with ceramic washbasin  
article no. 32751,  
front pull-out with soft closing,  
incl. odour trap made of plastic  
Interior fittings:  
– 1 plastic mat white  
Dimensions (w x h x d): 646 x 450 x 487 mm

**32770**  
**Vanity unit**  
compatible with ceramic washbasin  
article no. 32771,  
front pull-out with soft closing,  
incl. odour trap made of plastic  
Interior fittings:  
– 1 plastic mat white  
Dimensions (w x h x d): 996 x 450 x 487 mm

**32780**  
**Vanity unit**  
compatible with ceramic washbasin  
article no. 32781,  
front pull-out with soft closing,  
incl. odour trap made of plastic  
Interior fittings:  
– 1 plastic mat white  
Dimensions (w x h x d): 1296 x 450 x 487 mm



32710



32720



32730/32731

**32710**  
**Base unit**  
single door, with buffer,  
door hinge optionally left or right  
Interior fittings:  
– 2 glass shelves  
Dimensions (w x h x d): 350 x 470 x 335 mm

**32720**  
**Middle unit**  
single door, with buffer,  
door hinge optionally left or right  
Interior fittings:  
– 3 glass shelves  
Dimensions (w x h x d): 350 x 845 x 335 mm

**32730**  
**Tall unit**  
single door, with buffer,  
door hinge optionally left or right  
Interior fittings:  
– 4 glass shelves  
Dimensions (w x h x d): 350 x 1670 x 335 mm

**32731**  
**Tall unit**  
single door, with buffer,  
door hinge optionally left or right  
Interior fittings:  
– 2 glass shelves  
– 1 drawer  
– 1 laundry basket  
Dimensions (w x h x d): 350 x 1670 x 335 mm



12701



12702



12703



12704



12705



12706

**12701**  
**Mirror cabinet**  
1 hinged double-sided crystal mirror door,  
door hinge optionally left or right,  
mirrored sides  
Lighting:  
– LED lamp (1 x 6,5 W)  
Features:  
– 1 interior light switch  
– 1 interior shaver socket  
– 3 height adjustable glass shelves  
Dimensions (w x h x d): 500 x 752 x 143 mm

**12704**  
**Mirror cabinet**  
3 hinged double-sided crystal mirror doors,  
mirrored sides  
Lighting:  
– LED lamps (3 x 6,5 W)  
Features:  
– 1 exterior light switch  
– 2 interior shaver sockets  
– 3 x 3 height adjustable glass shelves  
Dimensions (w x h x d): 1000 x 752 x 143 mm

**12702**  
**Mirror cabinet**  
2 hinged double-sided crystal mirror doors,  
mirrored sides  
Lighting:  
– LED lamps (2 x 6,5 W)  
Features:  
– 1 exterior light switch  
– 2 interior shaver sockets  
– 2 x 3 height adjustable glass shelves  
Dimensions (w x h x d): 650 x 752 x 143 mm

**12705**  
**Mirror cabinet**  
3 hinged double-sided crystal mirror doors,  
mirrored sides  
Lighting:  
– LED lamps (3 x 6,5 W)  
Features:  
– 1 exterior light switch  
– 2 interior shaver sockets  
– 3 x 3 height adjustable glass shelves  
Dimensions (w x h x d): 1300 x 752 x 143 mm

**12703**  
**Mirror cabinet**  
2 hinged double-sided crystal mirror doors,  
mirrored sides  
Lighting:  
– LED lamps (2 x 6,5 W)  
Features:  
– 1 exterior light switch  
– 2 interior shaver sockets  
– 2 x 3 height adjustable glass shelves  
Dimensions (w x h x d): 800 x 752 x 143 mm

**12706**  
**Mirror cabinet**  
4 hinged double-sided crystal mirror doors,  
mirrored sides  
Lighting:  
– LED lamps (4 x 6,5 W)  
Features:  
– 1 exterior light switch  
– 4 interior shaver sockets  
– 4 x 3 height adjustable glass shelves  
Dimensions (w x h x d): 1600 x 752 x 143 mm

**NB:** All mirror cabinets illustrated in this brochure have the German specification.  
International electrical specifications on our products will vary according to individual countries' regulations and standards.



The extraordinary surface characteristics and extremely fine colour nuances of our products can only be reproduced to a certain degree in print. Only the original KEUCO products, which can be viewed in sanitary trade dealers' showrooms, can provide you with an optimum impression.

Reproduction and copying, even if only excerpts, are only permitted by explicit permission of the manufacturer, and with the inclusion of source information.  
KEUCO GmbH & Co. KG, Postfach 1365, D-58653 Hemer

We reserve the right to make engineering changes for the purpose of improvement, as well as colour and design changes that are deemed necessary. Errors and omissions excepted.

Concept, design, text and lithography: KONTRAST Communication Services GmbH, Düsseldorf  
Photography: Stephan Schacher, New York; Eva Gaida, Aalen; Thomas Krüsselmann, Viersen;  
Casa, Münster; provideo & fototeam, Menden  
CG Locations: Tino Schaedler, Los Angeles  
CG Shooting: The Scope, Digital Studio, Hamburg; Christian Stoll, Düsseldorf  
Printing: Meinders & Elstermann GmbH & Co. KG, Belm, Osnabrück  
Printed on GALAXI Keramik. Supplied by Papier Union.

For more information please visit [www.keuco.de](http://www.keuco.de)