

**SOAP  
DISPENSERS**

*keeping up healthy habits*





## SOAP DISPENSERS













*Large range of easy maintenance soap dispensers*

- Large selection of soap dispensers manufactured in various materials (stainless steel, plastic, etc.), different finishes (white, black, brushed, bright, etc.) different capacities (from 0.8 to 1.5 l) and different operating methods (automatic, push button, lever, etc.) for wall installation or recessed in the countertop
- Suitable for various types of soap (liquid, foam, spray), depending on the model
- Refillable soap tanks
- Exterior sight glass for soap level
- Lock with special key for protection against vandals

# SOAP DISPENSERS

surface

## AUTOMATIC

NEW	NEW	NEW	NEW
			
INNER TANK OF PP	INNER TANK OF PP	INNER TANK OF PP	INNER TANK OF PP
<b>DJ0037A</b> liquid soap	<b>DJ0037AB</b> liquid soap	<b>DJ0037AC</b> liquid soap	<b>DJ0037ACS</b> liquid soap
<b>DJF0038A</b>  foam	<b>DJF0038AB</b>  foam	<b>DJF0038AC</b>  foam	<b>DJF0038ACS</b>  foam
capacity: 1 L material: AISI 304 stainless steel finish: white epoxy	capacity: 1 L material: AISI 304 stainless steel finish: matte black epoxy	capacity: 1 L material: AISI 304 stainless steel finish: bright	capacity: 1 L material: AISI 304 stainless steel finish: satin
			

Automatic soap dispenser activated by means of an infrared sensor and manufactured in AISI 304 stainless steel. Liquid or foam soaps can be used depending on the chosen valve.

"Touch-free" operation reduces the risk of germs and cross-contamination during the washing process because the user does not have to touch the soap dispenser. It promotes health and wellness by preventing the spread of infectious diseases.

### DJ0037A · DJF0038A · DJ0037AB · DJF0038AB · DJ0037AC · DJF0038AC · DJ0037ACS · DJF0038ACS COMPONENTS AND MATERIALS

- Infra-Red detection (5 cm hand detection)
- Vandal resistant casing with lock
- Frontal content viewer
- Corrosion-resistant anti-drip valve
- Inner plastic tank, easily removable for cleaning
- Hinged cover for operator convenience and speed of service
- Opening on top with provided Mediclinics standard key
- Operates on 6 AA alkaline batteries

### DJ0037A · DJF0038A · DJ0037AB · DJF0038AB · DJ0037AC · DJF0038AC · DJ0037ACS · DJF0038ACS TECHNICAL SPECIFICATIONS

<b>DJ0037A · DJF0038A · DJ0037AB · DJF0038AB · DJ0037AC · DJF0038AC</b>	
<b>DJ0037ACS · DJF0038ACS</b>	
Capacity	1.0 L
Stainless steel thickness	0.8 mm
Weight (empty)	1.25 Kg
Recommended installation height	25 – 30 cm from countertop/shelve
<b>DJ0037A · DJ0037AB · DJ0037AC · DJ0037ACS</b>	
Suitable soaps	Liquid soap
Quantity dispensed per pump	1.5 ml
<b>DJF0038A · DJF0038AB · DJF0038AC · DJF0038ACS</b>	
Suitable soaps	Foam soap
Quantity dispensed per pump	1 ml



# SOAP DISPENSERS

surface / recessed

## AUTOMATIC



### DJ0160AS

capacity: 0.8 L

material: aluminium / ABS  
finish: chrome / black



UP TO 17,000 DOSES  
PER BATTERY SET

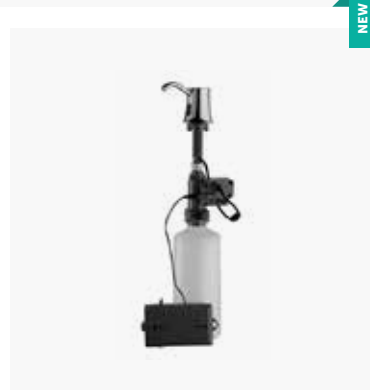

### DJ0252AC

capacity: 1.6 L

material: chrome-plated brass  
finish: bright



NEW

## DJ0160AS · DJ0252AC COMPONENTS AND MATERIALS

### DJ0160AS

- Automatic operation triggered by infrared sensors
- LED flashes when the batteries need to be replaced
- Suitable for neutral pH, chlorine-free liquid hand soap
- Suitable for disinfectant solutions, liquid soaps or hydroalcoholic gel
- Frontal content viewer
- Lock and special key supplied
- Transparent polyethylene tank
- ABS body with aluminium cover

### DJ0252AC

- Automatic soap dispenser for recessing to the countertop with infra-Red detection

- The dispenser can be located on the left or right of the countertop
- Auto adjustment of the sensing range
- Refillable soap plastic tank made of PE, easily removable for emptying and cleaning
- Operates on 4 x D 1.5 V alkaline batteries. Standby power consumption < 100 µA and service power consumption < 1 A
- Suitable for soaps with a viscosity 2,000 – 3,500 cP and with neutral pH
- LED indicator: Continuous red LED = Batteries low voltage; Flashing blue LED = Low soap level; Flashing red LED = Malfunction or the sensor is detecting an object.

## DJ0160AS · DJ0252AC TECHNICAL SPECIFICATIONS

### DJ0160AS

Capacity	0.8 L
Weight (empty)	0.75 Kg
Recommended installation height	20 – 25 cm from countertop
Suitable soaps	Chlorine-free hand soap with neutral pH, disinfectant solutions, liquid soaps and hydro alcoholic gel
Quantity dispensed per pump	1 ml

### DJ0252AC

Capacity	1.6 L
Weight (empty)	0.95 Kg
Suitable soaps	Soaps with a viscosity 2,000 – 3,500 cP and with neutral pH
Quantity dispensed per pump	0.8 – 2.2 ml
Protection rating	IP43

### DJ0160AS

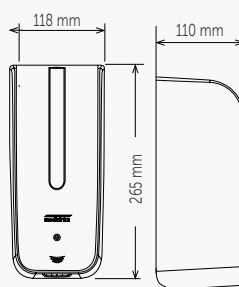

### DJ0252AC

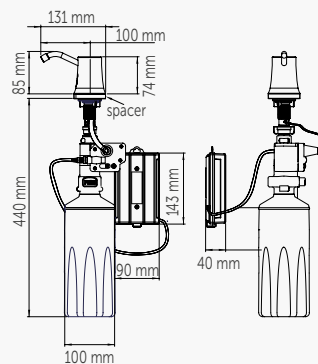

# SOAP DISPENSERS

surface / push - button



**DJ0031**  
liquid soap

**DJF0032**   
foam

**DJS0033**   
spray

capacity: **1,5 L**  
material: **AISI 304 stainless steel**  
finish: **white epoxy**



**DJ0031B**  
liquid soap

**DJF0032B**   
foam

**DJS0033B**   
spray

capacity: **1,5 L**  
material: **AISI 304 stainless steel**  
finish: **matte black epoxy**



**DJ0031C**  
liquid soap

**DJF0032C**   
foam

**DJS0033C**   
spray

capacity: **1,5 L**  
material: **AISI 304 stainless steel**  
finish: **bright**



**DJ0031CS**  
liquid soap

**DJF0032CS**   
foam

**DJS0033CS**   
spray

capacity: **1,5 L**  
material: **AISI 304 stainless steel**  
finish: **satin**



**DJ0031 · DJF0032 · DJS0033 · DJ0031B · DJF0032B · DJS0033B · DJ0031C · DJF0032C · DJS0033C · DJ0031CS · DJF0032CS · DJS0033CS** COMPONENTS AND MATERIALS

- Vandal resistant casing with lock
- Frontal content viewer
- Stainless steel push-button
- Corrosion-resistant anti-drip valve
- Inner tank 2.5 mm thick made of translucent polypropylene
- Easily removable inner tank
- Hinged cover for operator convenience and speed of service
- Opening on top with provided Mediclinics standard key

- DJ0031 · DJ0031B · DJ0031C · DJ0031CS**
- Admits liquid soap or hydro-alcoholic gel
- DJF0032 · DJF0032B · DJF0032C · DJF0032CS**
- Exclusive use for foam soap
- DJS0033 · DJS0033B · DJS0033C · DJS0033CS**
- Exclusive use for disinfectant liquids

ONE SOAP DISPENSER, 3 POSSIBLE VALVES!

INTERCHANGABLES VALVES

liquid soap    foam    spray

RCDJ0031 V / RCDJF0032 V / RCDJS0033 V1

**DJ0031 · DJF0032 · DJS0033 · DJ0031B · DJF0032B · DJS0033B · DJ0031C · DJF0032C · DJS0033C · DJ0031CS · DJF0032CS · DJ0033CS** TECHNICAL SPECIFICATIONS

Capacity	1.5 L
Stainless steel thickness	0.8 mm
Weight (empty)	1.25 Kg
Recommended installation height	15 - 20 cm from countertop
<b>DJ0031 · DJ0031B · DJ0031C · DJ0031CS</b>	
Suitable soaps	Liquid soaps and hydroalcoholic gels
Quantity dispensed per pump	1.5 ml
<b>DJF0032 · DJF0032B · DJF0032C · DJF0032CS</b>	
Suitable soaps	Foam soaps
Quantity dispensed per pump	1 ml
<b>DJS0033 · DJS0033B · DJS0033C · DJS0033CS</b>	
Suitable soaps	Liquid disinfectant soaps
Quantity dispensed per pump	0.8 ml

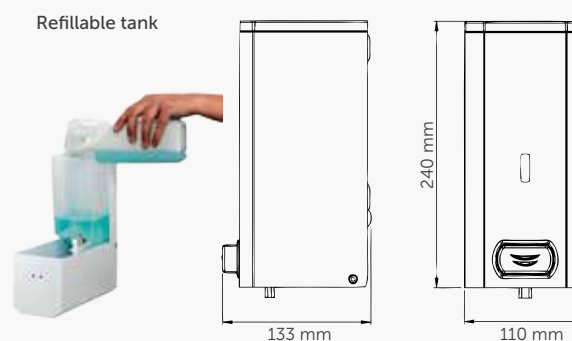

# SOAP DISPENSERS

surface / push - button



INNER TANK OF PP

### DJ0040

capacity: 1,5 L

material: AISI 304 stainless steel  
finish: white epoxy



INNER TANK OF PP

### DJ0040B

capacity: 1,5 L

material: AISI 304 stainless steel  
finish: matte black epoxy



INNER TANK OF PP

### DJ0040C

capacity: 1,5 L

material: AISI 304 stainless steel  
finish: bright



INNER TANK OF PP

### DJ0040CS

capacity: 1,5 L

material: AISI 304 stainless steel  
finish: satin



## DJ0040 · DJ0040B · DJ0040C · DJ0040CS COMPONENTS AND MATERIALS

- Vandal resistant casing with lock
- Frontal content viewer
- Stainless steel push-button
- Corrosion-resistant anti-drip valve
- Inner tank made of 2,5 mm thickness translucent polypropylene
- Easily removable inner tank
- Hinged cover for operator convenience and speed of service
- Opening on top with provided mediclinics key that allows soap refill
- Allows disinfectant solutions, liquid soap or hydro-alcoholic gel

## DJ0040 · DJ0040B · DJ0040C · DJ0040CS TECHNICAL SPECIFICATIONS

Capacity	1.5 L
Stainless steel thickness	0.8 mm
Weight (empty)	1.2 Kg
Recommended installation height	15 – 20 cm from countertop
Suitable soaps	disinfectant solutions, liquid soaps or hydro-alcoholic gel
Quantity dispensed per pump	0.8 ml

Refillable tank

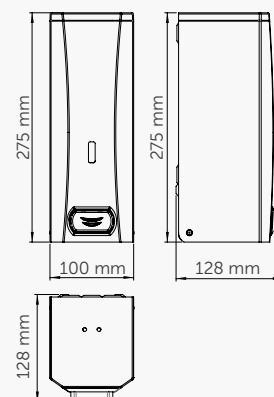

# SOAP DISPENSERS

surface / push - button



**DJ0112C**  
capacity: 1,1 L  
material: **AISI 304 stainless steel**  
finish: **bright**

---

**DJ0112CS**  
capacity: 1,1 L  
material: **AISI 304 stainless steel**  
finish: **satin**



**DJ0111C**  
capacity: 1,1 L  
material: **AISI 304 stainless steel**  
finish: **bright**

---

**DJ0111CS**  
capacity: 1,1 L  
material: **AISI 304 stainless steel**  
finish: **satin**

## DJ0112C · DJ0112CS · DJ0111C · DJ0111CS COMPONENTS AND MATERIALS

- Stainless steel body
- Fully welded structure
- Frontal content viewer
- Lock and special key supplied
- Suitable for chlorine-free hand soap with a neutral pH
- Polyethylene inner tank
- Chromed brass piston
- Chrome-plated ABS thermoplastic valve

## DJ0112C · DJ0112CS · DJ0111C · DJ0111CS TECHNICAL SPECIFICATIONS

DJ0112C · DJ0112CS · DJ0111C · DJ0111CS	
Capacity	1.1 L
Stainless steel thickness	1 mm
Weight (empty)	0.7 Kg
Recommended installation height	10-15 cm to countertop
Suitable soaps	chlorine-free hand soap with a neutral pH
Quantity dispensed per pump	1.1 ml

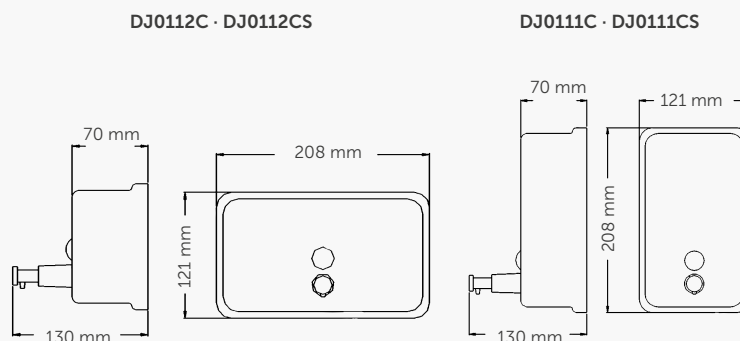



# SOAP DISPENSERS



surface / push - button



**DJ0115C**  
capacity: 1,3 L

---

material: **AISI 304 stainless steel**  
finish: **bright**

**DJ0115CS**  
capacity: 1,3 L

---

material: **AISI 304 stainless steel**  
finish: **satin**



## DJ0115C · DJ0115CS COMPONENTS AND MATERIALS

- Stainless steel body
- Fully welded structure
- Inner tank made of polyethylene to prevent oxidation
- Black ABS thermoplastic push-button
- Suitable for chlorine-free hand soap with a neutral pH

## DJ0115C · DJ0115CS TECHNICAL SPECIFICATIONS

DJ0115C · DJ0115CS	
Capacity	1.3 L
Stainless steel thickness	1 mm
Weight (empty)	0.7 Kg
Recommended installation height	10 –15 cm from countertop
Suitable soaps	Chlorine-free hand soap with neutral pH
Quantity dispensed per pump	0.7 ml

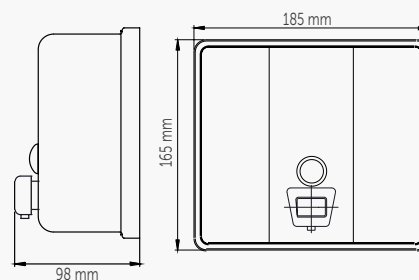

# SOAP DISPENSERS

surface / push-button



**DJ0010F**  
capacity: 1,1 L

---

material: **ABS**  
finish: **white / smoked**



**DJ0020F**  
capacity: 1,1 L

---

material: **ABS**  
finish: **black / smoked**



## DJ0010F · DJ0020F COMPONENTS AND MATERIALS

- ABS thermoplastic lid
- Standard mediclinics lock and key®
- ABS thermoplastic push-button
- SAN thermoplastic tank
- Corrosion-resistant anti-drip valve
- Suitable for chlorine-free hand soap with a neutral pH
- Suitable for disinfectant solutions, liquid soaps or hydroalcoholic gel

## DJ0010F · DJ0020F TECHNICAL SPECIFICATIONS

Capacity	1.1 L
Body thickness	3 mm
Weight (empty)	0.3 Kg
Recommended installation height	15 - 20 cm to countertop
Suitable soaps	chlorine-free hand soap with a neutral pH, disinfectant solutions, liquid soaps or hydroalcoholic gel
Quantity dispensed per pump	1.2 ml

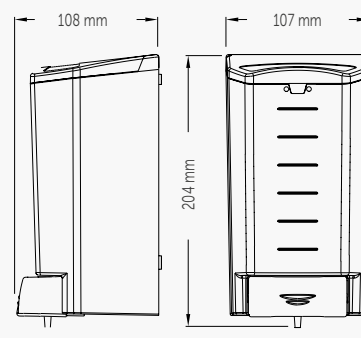

# SOAP DISPENSERS

surface / lever

**DJP0034**  
liquid soap

**DJFP035**  
foam

**DJSP036**  
spray

capacity: 1.5 L  
material: AISI 304 stainless steel  
finish: white epoxy

INNER TANK OF PP

**DJP0034B**  
liquid soap

**DJFP035B**  
foam

**DJSP036B**  
spray

capacity: 1.5 L  
material: AISI 304 stainless steel  
finish: matte black epoxy

INNER TANK OF PP

**DJP0034C**  
liquid soap

**DJFP035C**  
foam

**DJSP036C**  
spray

capacity: 1.5 L  
material: AISI 304 stainless steel  
finish: bright

INNER TANK OF PP

**DJP0034CS**  
liquid soap

**DJFP035CS**  
foam

**DJSP036CS**  
spray

capacity: 1.5 L  
material: AISI 304 stainless steel  
finish: satin

INNER TANK OF PP

**DJP0034 · DJFP035 · DJSP036 · DJP0034B · DJFP035B · DJSP036B · DJP0034C · DJFP035C · DJSP036C · DJP0034CS · DJFP035CS · DJSP036CS** COMPONENTS AND MATERIALS

- Vandal resistant casing with lock
- Frontal content viewer
- Actuated by means of a stainless steel lever
- Corrosion-resistant anti-drip valve
- Inner tank, 2.5 mm thick of translucent polyethylene
- Easily removable inner tank
- Hinged cover for operator convenience and speed of service

- Opening on top with provided Mediclinics standard key
- Admits liquid soap or hydro-alcoholic gel
- Exclusive use for foam soap
- Exclusive use for disinfectant liquids

ONE SOAP DISPENSER, 3 POSSIBLE VALVES!

INTERCHANGABLES VALVES

liquid soap    foam    spray

RCDJ0031 V / RCDJF0032 V / RCDJS0033 V1

**DJP0034 · DJFP035 · DJSP036 · DJP0034B · DJFP035B · DJSP036B · DJP0034C · DJFP035C · DJSP036C · DJP0034CS · DJFP035CS · DJSP036CS** TECHNICAL SPECIFICATIONS

Capacity	1.5 L
Stainless steel thickness	0.8 mm
Weight (empty)	1.35 Kg
Recommended installation height	15 – 20 cm from countertop
<b>DJP0034 – DJP0034B – DJP0034C – DJP0034CS</b>	
Suitable soaps	Liquid soaps and hydro-alcoholic gels
Quantity dispensed per pump	1.5 ml
<b>DJFP035 – DJFP035B – DJFP035C – DJFP035CS</b>	
Suitable soaps	Foam soaps
Quantity dispensed per pump	1 ml
<b>DJSP036 – DJSP036B – DJSP036C – DJSP036CS</b>	
Suitable soaps	Liquid disinfectant soaps
Quantity dispensed per pump	0.8 ml

Refillable tank

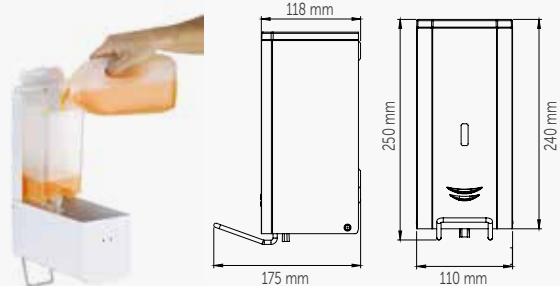

# SOAP DISPENSERS

*recessed / push button*



**DJE0010CS**  
capacity: **1.4 L**

material: **AISI 304 stainless steel**  
finish: **satin**

NEW



**DJT118**  
capacity: **0.95 L**

material: **chrome-plated brass**  
finish: **bright**

## DJE0010CS · DJT118 COMPONENTS AND MATERIALS

### DJE0010CS

- Recessed soap dispenser made of AISI 304 stainless steel
- Chromed brass push button
- Inner plastic tank
- Lock with a supplied special key
- One-piece frontal part
- Frontal content viewer
- Anti-drip valve
- Suitable for chlorine-free hand soap with a neutral pH

### DJT118

- Removable valve for refiling in the upper part
- Vandal-resistant polyethylene tank
- Lock and special key supplied
- Suitable for chlorine-free hand soap with a neutral pH of 5,5, disinfectant solutions, liquid soaps and hydroalcoholic gel
- Bright finish chromed brass piston and spout, 90 mm long
- Fixed push-button

## DJE0010CS · DJT118 TECHNICAL SPECIFICATIONS

### DJE0010CS

Stainless steel thickness	0.8 mm
Weight (empty)	1.4 Kg
Recommended installation height	20-25 cm from countertop
Suitable soaps	Chlorine-free hand soap with neutral pH
Quantity dispensed per pump	1.1 ml



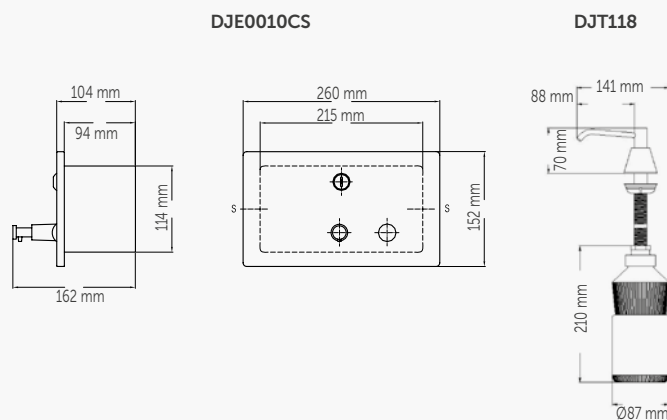

### DJT118

Weight (empty)	0.425 Kg
Recommended installation height	10 –15 cm from countertop
Suitable soaps	Chlorine-free hand soap with neutral pH of 5.5, disinfectant solutions, liquid soaps and hydro alcoholic gel
Quantity dispensed per pump	1 ml
Countertop hole	Ø 25 mm
Escutcheon	Ø 50 mm
Shank length	118 mm

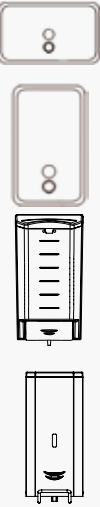

# SOAP DISPENSERS

Table

	MODEL	OPERATION		MATERIAL / FINISH							TANK	RECESSED
		manual	autom.	AISI 304 stainless steel white	AISI 304 stainless steel matte black	AISI 304 stainless steel bright	AISI 304 stainless steel satin	chrome plated brass	aluminium /ABS	ABS	thermo-plastic	
	DJ0037A-B-C-CS		•	•	•	•	•				•	
	DJF0038A-B-C-CS		•	•	•	•	•				•	
	DJ0160AS		•						•		•	
	DJ0252AC		•					•			•	•
	DJ0031-B-C-CS	•		•	•	•	•				•	
	DJF0032-B-C-CS	•		•	•	•	•				•	
	DJS0033-B-C-CS	•		•	•	•	•				•	
	DJ0040	•		•							•	
	DJ0040B				•						•	
	DJ0040C	•				•					•	
	DJ0040CS	•					•				•	
	DJ0112C	•				•					•	
	DJ0112CS	•					•				•	
	DJ0111C	•				•					•	
	DJ0111CS	•					•				•	
	DJ0115C	•				•					•	
	DJ0115CS	•					•				•	
	DJ0010F	•								•	•	
	DJ0020F	•								•	•	
	DJP0034-B-C-CS	•		•	•	•	•				•	
	DJFP035-B-C-CS	•		•	•	•	•				•	
	DJSP036-B-C-CS	•		•	•	•	•				•	
	DJE0010CS	•					•				•	•
	DJT118	•						•			•	•

Suitable soaps table				
Soap dispenser code	Type of pump	Spare part Code	Allowed soaps	Density (Kg/dm <sup>3</sup> )
DJ0031-B-C-CS DJP0034-B-C-CS DJ0037A-B-C-CS	SOAP PUMP	RCDJ0031-V	Liquid soaps and hydroalcoholic gels	0.9 – 1.35
DJF0032-B-C-CS DJFP035-B-C-CS DJF0038A-B-C-CS	FOAM PUMP	RCDJF0032-V	Foam soaps	0.95 – 1.05
DJS0033-B-C-CS DJSP036-B-C-CS	SPRAY PUMP	RCDJS0033-V1	Liquid disinfectant soaps <sup>(1)</sup>	0.8

(1) Maximum content of 85% of alcohol

# SOAP DISPENSERS

Table

INSTALLATION		CAPACITY								TYPES OF SOAP				MODEL
Vert.	Horiz.	1.6 L	1.50 L	1.4 L	1.3 L	1.10 L	1 L	0.95 L	0.80 L	Neutral PH	Disinfectant	Foam	Spray	
•							•			•				DJ0037A-B-C-CS
•							•					•		DJF0038A-B-C-CS
•									•	•	•			DJ0160AS
•		•								•				DJ0252AC
•			•							•	•			DJ0031-B-C-CS
•			•									•		DJF0032-B-C-CS
•			•								•		•	DJS0033-B-C-CS
•			•							•	•			DJ0040
•			•							•				DJ0040B
•			•							•	•			DJ0040C
•			•							•	•			DJ0040CS
	•					•				•				DJ0112C
	•					•				•				DJ0112CS
•						•				•				DJ0111C
•						•				•				DJ0111CS
	•				•					•				DJ0115C
	•				•					•				DJ0115CS
•						•				•	•			DJ0010F
•						•				•	•			DJ0020F
•			•							•	•			DJP0034-B-C-CS
•			•									•		DJFP035-B-C-CS
•			•										•	DJSP036-B-C-CS
	•			•						•				DJE0010CS
•								•		•	•			DJT118